

RAY MEARS

OUTDOOR SURVIVAL HANDBOOK

A photograph of Ray Mears, a man with short brown hair, wearing a dark jacket and green cargo pants. He is sitting in a forest, looking directly at the camera. He is holding a map in his hands and has a black tripod in front of him. The background is a blurred forest scene with trees and branches.

**A GUIDE TO THE RESOURCES AND MATERIALS
AVAILABLE IN THE WILD AND HOW TO USE THEM
FOR FOOD, SHELTER, WARMTH AND NAVIGATION**

Contents

Introduction	8
Clothing	14
Personal kit	16
Under cover	18
Base camp kit	20
Cutting tools	21
Navigation	22
Using OS maps	24
Contours	25
Using a Silva compass	26
Resection	27
Natural indicators of direction	28

SPRING 30

Animal kingdoms	32
Tracks – common small mammals and birds	34
Tracks – large mammals	36
Shelter	38
Making a simple shelter	40
Fire	42
How a fire burns	44
Tinders	46
Fire from sparks	48
Fire by friction	50
Organising your fire	52
Water	54
When the sap flows	56
Cordage	58
Preparing bark for cordage	60
Plaited cordage	62
Laid cordage	64
Birch bark	66
Working with birch bark	67
Resin	68
The pursuit of food	70
The importance of roots	72
The digging stick	73
Salads and greens	74
Sweet roots	76
Drinks and flavourings	78

SUMMER 80

Animal kingdoms	82
Droppings	84
Shelter	86
Water	88
Fire	90
Hygiene	92
The sweat lodge	94
Senses	96
Seeing more	98
Choosing your binoculars	99
Setting up	100
Finding wild animals	102
Basketry	104
Coiling	106
Plaiting and twining	108
Basketry projects	110
Pottery	112
Making a pot	114
Finishing and firing	116
The pursuit of food	118
Fishing	120
Fishing hooks	122
Filleting a fish	124
Drying meat and fish	126
Smoking meat and fish	127
Cooking greens	128
Fruits	130
Flour	132
Cooking	134
The steam pit	136
The mud oven	137
The harvest feast	138
Recipes	140

AUTUMN 142

Animal kingdoms	144
Feeding signs	146
Shelter	148
Beds and bedding	150
Making a simple bed	151
Duvet	152
Fire	154
Nettle cordage	156
The pursuit of food	158
Primitive hunting	160
Skinning a small mammal	162
Wasting nothing	164
Preparing skins	166
End-of-season-treats	168
Life out of death	170
Risks and dangers	171
Edible fungi	172
Utility	174

WINTER 176

Animal kingdoms	178
Winter trails	180
Winter shelters	182
Quinze	184
Group shelter	186
Organising a bivouac	188
Insulation	190
Heated beds	192
Fire	194
Transporting fire	196
Water	198
Cordage	200
Withes cordage	202
Clematis cordage	203
Carving	204
Carving techniques	206
Carving projects	208
Winter lights	210
Lamp	211
Special equipment	212
Snow goggles	213
Snow-shoe (Roycraft pattern)	214
The pursuit of food	216
Winter plants	218
Seashore foods	220
Shoreline edibles	222
Seaweed	224
Trapping	226
Storytelling	228

Appendices

1 Useful addresses	230
2 Sharpening a knife	232
3 Coppicing	234

Index	236
-------------	-----

Making a simple shelter

There are many different types of shelter, but for speed and efficiency few can equal these simple bivouacs. In a good location they can be built without a knife or any cordage from dead materials lying around. They are small and well insulated to help retain your body-heat, and they will keep out even the worst weather. If well built they are a stronger and cosier refuge than the most modern hike tent. They block out the sound of the noisiest gale, letting you sleep.

Remember to keep the bivouac's size as small as comfort will allow. Check your measure inside the shelter as you build it.

Given a good location, an average person working steadily in bad light can build the solo 'kennel' in about two hours. Two people can build the two-person kennel in half that time – as apart from an extra ridge-pole, the shelter contains the same amount of roofing material.

Two-person kennel

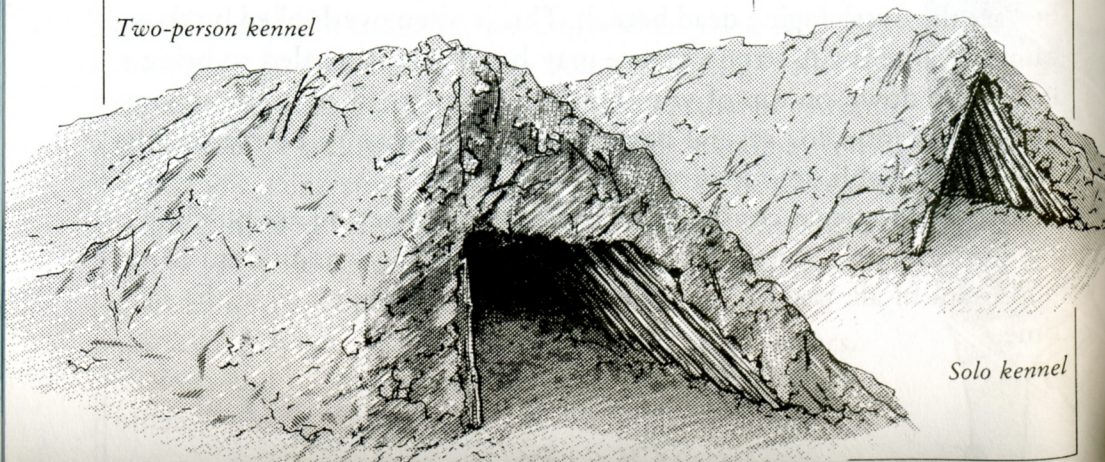

Solo kennel

What you will need

One or two long, straight and strong ridge-poles, plus one or two short major supports

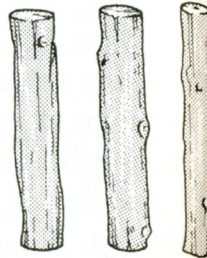

Many slim pieces of dead wood for the walls



Dead leaves, humus or turfs for thatching, plus light brushwood

One-person kennel



1 Construct a strong tripod framework. Forked supports for the two short legs will save a need for cordage.

2 Measure up the height and width of the shelter with your body. It should provide just enough room to turn over with all of your bedding.

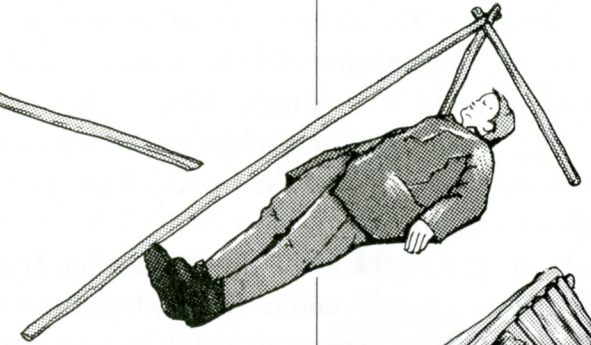

3 Using the dead branches, wall the sides of the shelter. These rafters should be as close together as possible, and the ends must not protrude more than 4 cm (1½ in) above the ridge-pole.

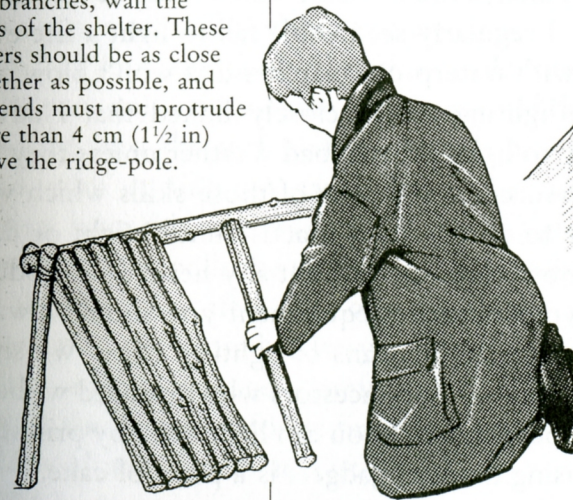

4 Thatch with an arm's depth of leaves or humus. Anchor down with a covering of light brushwood. Don't leave rafters protruding from the top of the shelter or rain will run inside.

Two-person kennel

1 Construct a tripod from two long poles and one short pole. Again try to avoid the need for cordage.

2 Wall as for the one-person kennel. Close off some of the gap between ridge-poles with cross-battens. Thatch and finish as before.

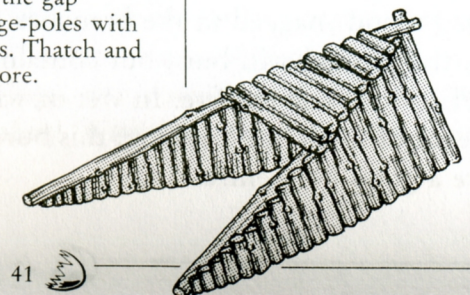
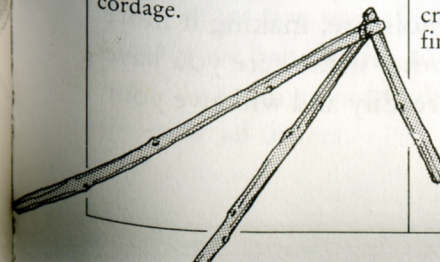

Fire

Woodsmoke! The very scent of it transports me down a trail of memories, to campsites alive with the fire's flickering shadows, and to friends sharing its warmth. When spirits are high, a fire's flames provide joyful light; and when spirits are low, the consoling warmth of the embers will thaw the frozen heart. For me, life is inconceivable without a camp-fire.

At the practical level, a fire is essential. It dries our clothes, warms us when we are cold, cooks our food, purifies our water, provides light at night, drives away biting insects and much more. Being able to start and look after a fire is a skill which must be mastered. It is not easy – I regularly see people fail to light a fire even when equipped with waterproof matches that won't blow out. Morale and fire-lighting are so closely linked that I advise people not to try to light a fire in bad weather unless they are certain they will succeed. It is one of those skills which you just have to practise and practise until, night or day, sun or snow, you can without any hesitation produce fire. In your outdoors equipment you should always carry some reliable means of lighting a fire. We shall learn the ways of our ancestors who managed without matches, because once you can light a fire by primitive means, using modern gadgets is a piece of cake.

Good in emergencies, lifeboat matches cannot be blown out in strong winds or damp weather

Starting and managing your fire

When starting a fire remember to search out the driest kindling and fuel available. This should preferably be dead wood snagged in the branches above ground. Dead wood found on the ground will burn but contains more moisture, making it more difficult to start the fire. In wet or windy weather make sure you have plenty of small fine kindling; this burns more readily and will give your fire a good hot centre.

Remember also that fire prefers to burn upwards. Flat fires smoulder; tall fires blaze. When lighting your fire, build upwards for a blaze.

But just lighting the fire is only the start. Your fire is a versatile tool which you can adapt and change to suit a wide variety of situations. Correctly managed, it will always be perfectly matched to the task you put it to, and in between it will burn slowly and efficiently, requiring the minimum of looking after. With a deft flick of the embers an experienced fire-tender makes fire management look easy; but in fact it usually takes people several years to learn to make the best use of this resource. Bear in mind that there is an inherent skill involved in tending a fire, and you will probably learn more quickly. Whether for light, warmth, cooking or company, there is a specifically related fire lay.

If you visit any national park or wilderness area, you will often come across an old fire site scorched into the turf beside a stream and usually filled with rusting tin cans. While the land will recover from this careless abuse, it shows a great lack of respect and spoils the sanctity of that stream-bank for all who come after. Use of a fire brings with it a responsibility to leave no traces behind. Always choose a location where the fire will do no obvious damage – preferably bare earth. Be constantly aware, too, of the danger of forest fires; camp-fires should be sited in an area of cleared underbrush at least 4 m (12 ft) across.

While surrounding a fire with stones fits the romantic image of camping, in reality it achieves little more than the scorching of the rocks, which remain a testament to your presence for many years to come. In some controlled wilderness areas fires are permitted when there is no fire risk. If you are forbidden to have a fire, it is better for every other fire user if you obey the regulations. Although they may sometimes benefit the natural ecology, promoting plant regeneration, forest fires are a serious threat to safety. With fire, safety considerations override all others.

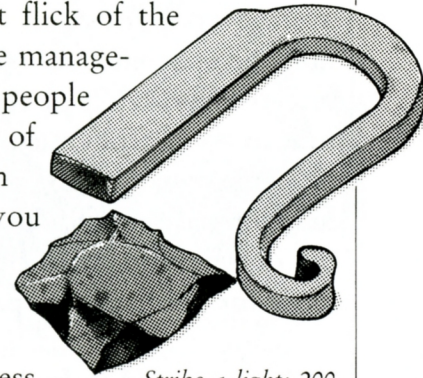

Strike-a-light: 200 years ago this was the principal way people lit their fires, by striking sparks from a steel with a gun flint

How a fire burns

There are three vital ingredients to fire: fuel, oxygen and heat. For efficient burning there must be an unrestricted supply of each. The average wood fire consists of a fairly random lattice of fuel. This lattice must be open enough to allow oxygen in the form of air to pass freely into the fire, while at the same time being tight enough to allow the heat to travel from one piece of fuel to the next. If the fuel is damp or too large to catch light, the fire will smoulder or go out. Many a novice has suffered the smouldering fire, the fire with too little air supply or the one which started but then went out because the lattice was too loose for the flames to pass.

What you need to build a fire

Extra-fine kindling

Very dry twigs 30 cm (1 ft) long and matchstick-thin. Should catch light from a match alone. Keep these twigs at least two hand-spans long.

Fine kindling

Thicker than a match but thinner than a pencil. Brittle dry. Gather plenty.

Kindling

Brittle-dry wood of pencil thickness. This really gets the fire cracking. Again, gather plenty. Broken into pieces a hand-width long, this kindling is the best fuel to use when you need to control the heat of a cooking fire.

Small fuel

Thicker than a pencil but not thicker than your thumb, this fuel is the beginnings of the fire proper.

Main fuel

Sticks thicker than your thumb which you can break over your knee. For most trail fires this is the largest fuel needed. Anything larger counts as 'large fuel' and is more appropriate to fixed camp use or special fire lays.

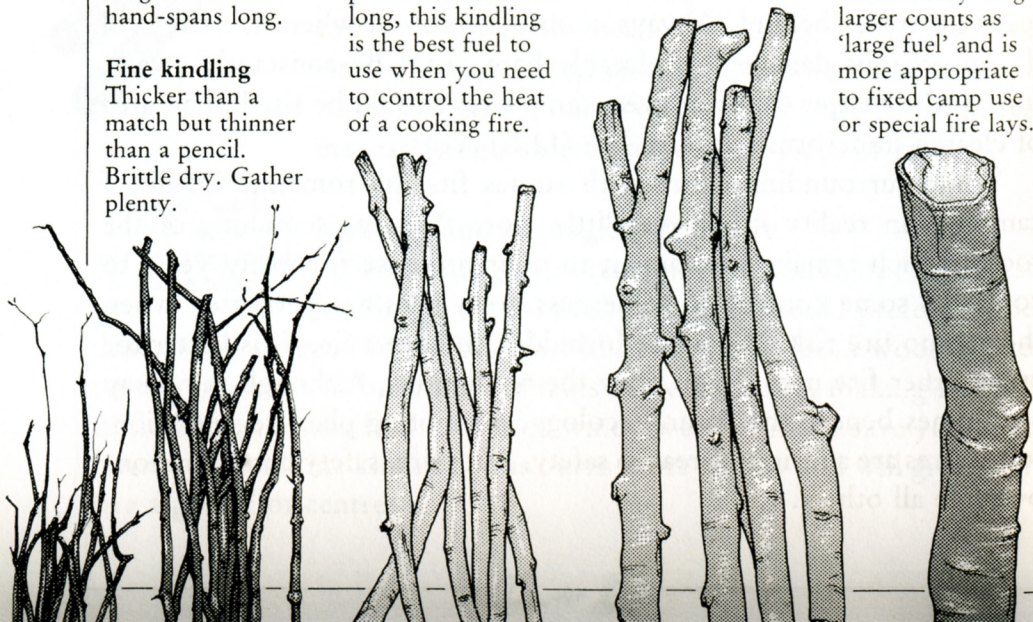

Building a fire

1 Choose a suitable fire site and gather all the necessary fuel. Use small fuel to build a platform about 30 cm (1 ft) square. This will protect your tinder from the damp ground and burn quickly at the fire's heart.

2 Place a grapefruit-sized bundle of teased fibrous tinder on the platform (see pp. 46-7).

3 Take two full handfuls of extra-fine kindling and position them against the tinder with their tops overlapping directly above the tinder.

4 Light the tinder. As the flames rise, position the kindling in the flames from the tinder bundle. When flames burn through above the kindling, add the next size up, and continue this until you are burning main fuel.

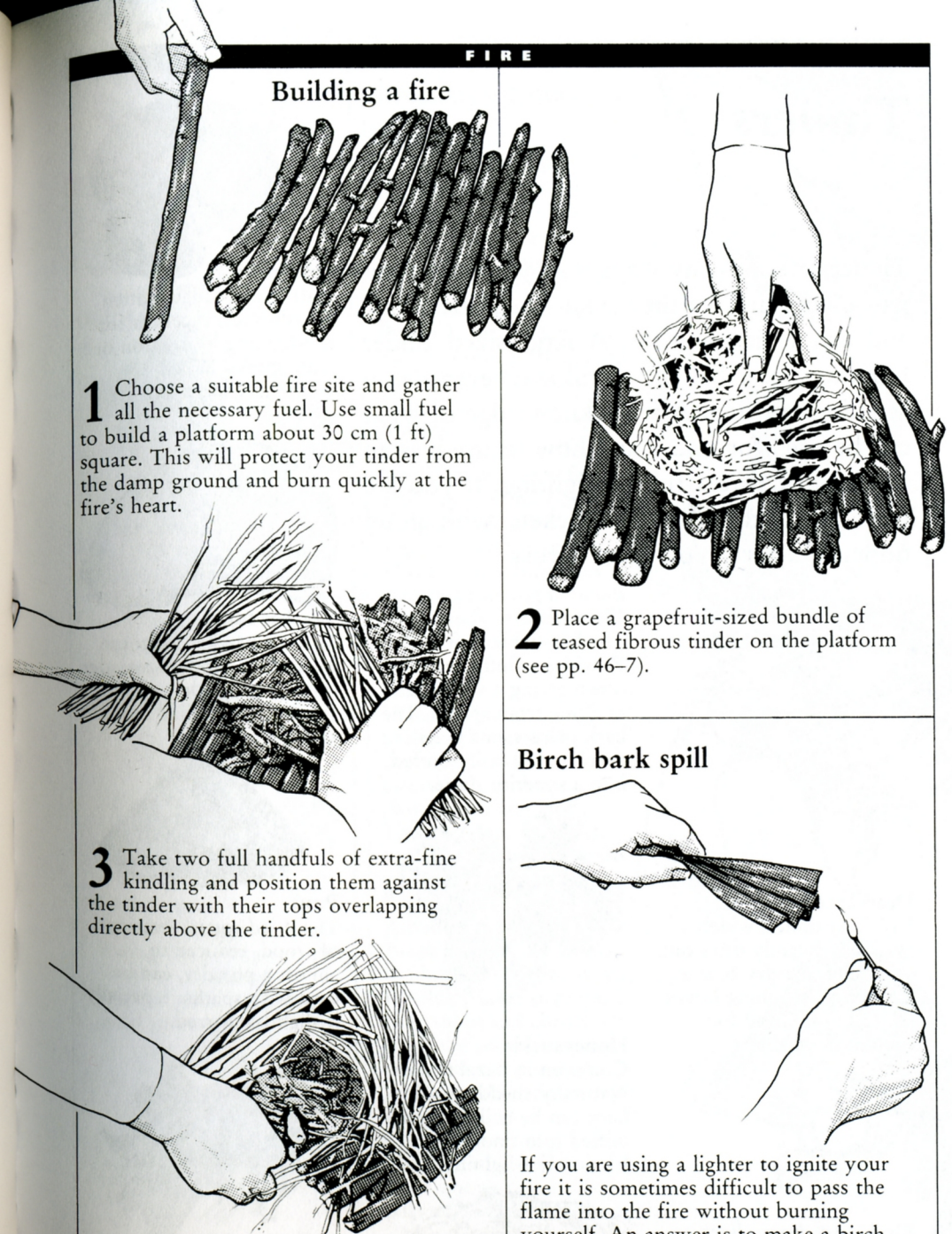

Birch bark spill

If you are using a lighter to ignite your fire it is sometimes difficult to pass the flame into the fire without burning yourself. An answer is to make a birch bark spill. Birch bark burns well because of the oils it contains, but it tends to curl up tight as it does so. To make a spill you will need to fold a small square sheet of the bark concertina fashion to prevent it curling up. Light this from your lighter.

Tinders

Tinders are in many ways the most important part of any fire, for they create the initial flame and enable it to grow. A large-sized tinder bundle, soccer-ball size, will start even damp kindling burning. A wide knowledge of what can be used for tinder and how to use it is an essential of successful fire-lighting. If you are wise you will fill your pockets with good tinder whenever you come across it.



Clematis

The fire-lighter's friend. Provides a fluffy seed down giving a short burst of flame from sparks. The bark of its stems peels away and is easily buffed into a superior tinder.



Dead bracken

Excellent tinder, widely available. Readily dries out, especially in a dry breeze. Collect by stripping leaves from stems. Good for friction fire-lighting.



Birch and cherry bark
Burns long and hot. Bark peels naturally in small strips - gather and light with a match for a long-lasting hot centre for fire-lighting.



Honeysuckle

Common in hazel copses. Naturally shedding silky bark can be collected and buffed into tinder for friction fire-lighting.

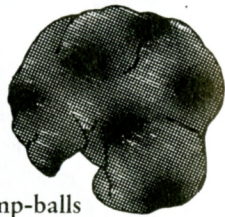

Cramp-balls

Hard black fungus, often on ash trees, excellent for fire-lighting by friction or with sparks. When dry, will take a spark and smoulder.

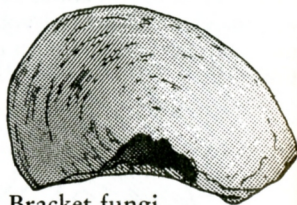

Bracket fungi

Various bracket fungi can be used to produce a tinder known as amadou. Good for use with a flint and steel.



Punk

The dried rotted remains of wood, reduced to almost a powder, can be used with sparks, especially if slightly charred.



Cedar bark

Fibrous and stringy, an excellent tinder to use with a magnifying glass. Buffed-up fibres make good friction tinder.



Rosebay willow herb

Seed-heads, collected into a tight cotton-wool-like mass, make good tinder for flint and steel. Improved by a slight charring.

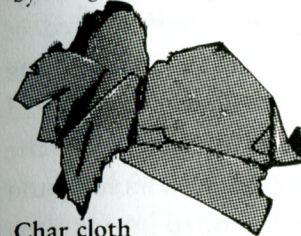

Char cloth

A 100% cotton or silk cloth, set alight and then stamped out when charred very dark brown, was once commonly used and takes a spark readily.



Cotton grass

Found in boggy ground during late spring and early summer. Collected together, this is another good spark tinder.



Dry grass

Humblest of all the tinders, dry grass can be easily buffed into a good tinder bundle for friction fire-lighting.

Preparing tinders

Body drying

If your best available tinder is damp or wet, it may be possible to dry it by rubbing on dry absorbent clothing, particularly the thigh of polycotton trouser legs. Placed in the pockets of such trousers, body warmth will dry out the tinder.

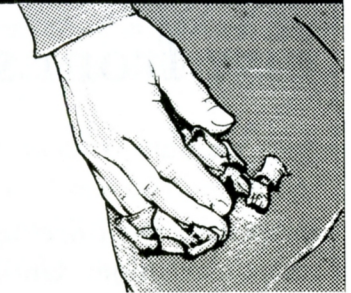

Buffing

The best tinder for friction fire-lighting is very fine and fluffy. Many fibrous tinders need to be improved in this respect. This can be achieved by vigorous rubbing between your hands or against a dry rock surface.

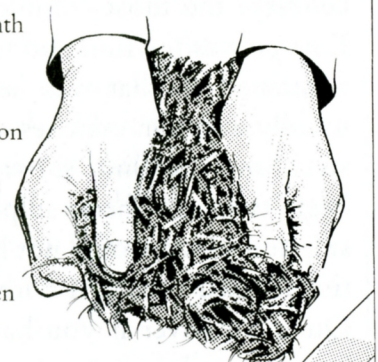

Nicheing

Using the point of your knife, make a small depression in the tinder into which to drop a glowing friction ember. This gives more surface area to catch and prevents ember cooling too fast.

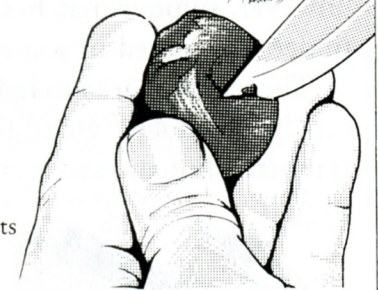

Amadou

Break or cut open one of the bracket fungi to reveal the fluffy layer between pore tubes and cuticle. With the other areas cut away from it you have crude amadou for use with sparks.

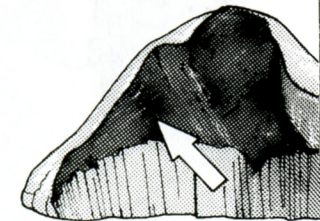

Tinder coils

Take one or two squares of paper-like birch bark about 22 cm (9 in) square. Roll into tight cigars and slice off finely to produce many tiny coils for your friction tinder bundle. Slightly difficult to ignite, but burn hot and long.



Fire from sparks

In the history of fire-lighting, self-igniting friction matches are only a recent invention. Until their introduction in the late seventeenth century, the most commonly employed fire-lighting method used in Europe was the flint and steel. In civilised circumstances the tinder box contained all that was necessary: the flint, the steel, the tinder and usually sulphur matches and a candle. The process was to strike the steel with the flint, showering sparks on to the tinder, which would begin to glow. Then a sulphur match – a simple spill dipped into molten sulphur which would not light by friction – was touched to the glowing tinder until it caught with a blue flame. Thus the candle could be lit. Quite a palaver if you had to rise quickly in the night. On the trail, however, sulphur matches were hard to come by. Instead, the glowing tinder was placed in some more fibrous tinder and blown to flame.

The use of sparks to light fires is today still a valid technique. Sparks can be produced from lighters which have run out of fuel, from synthetic flint and steels and from the ancient steel strike-a-light or the

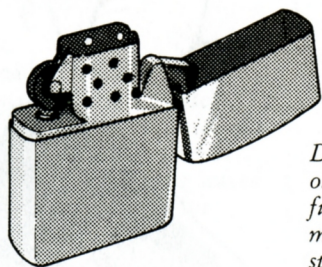

Don't discard an old lighter whose fuel is used up; it may still provide sparks

C-shaped strike-a-light

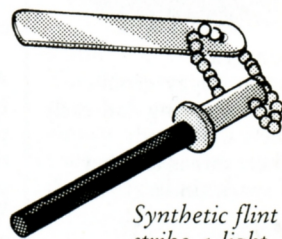

Synthetic flint strike-a-light

Flint piece must have a thin sharp edge

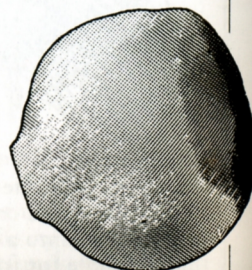
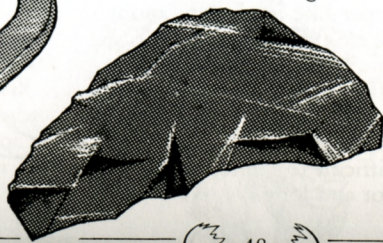

Iron pyrites

back of a carbon-steel knife. If you have access to iron pyrites, two pieces struck together, or one piece struck with flint, gives dull red sparks.

The best spark-producer of all these is the modern synthetic flint bar, which frequently comes attached to a block of magnesium. Scrape this bar with the back of your knife with a sort of wrist-flick to produce a bright shower of sparks which will ignite a wide range of tinders or even light trail stoves. So good is this shower of sparks that even the woody remains of umbellifer flowers can be drawn together and ignited. The magnesium block can be scraped to produce a small pile of shavings that will easily ignite from the sparks. Place the magnesium on a pile of tinder that will take light when ignited. An excellent tinder is the skeleton from a decomposing holly leaf. Sandwich the magnesium between two such leaves and set it alight by showering the sparks to fall through the leaf ribs. The leaves act as both tinder and a basket to prevent the magnesium blowing away.

Steel strike-a-light

The most practically shaped steel was C-shaped. The tinder was held on top of the flint, which was held steady while the steel was struck against it. This caused the sparks, tiny curls of red-hot steel, to be thrown upwards on to the tinder. Held in this way, the tinder was protected from the elements.

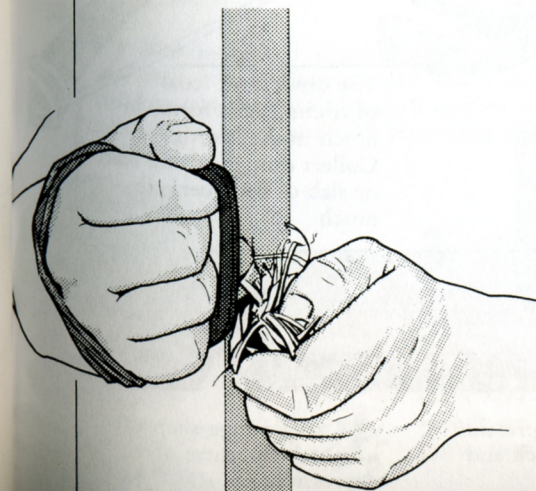

Knife strike-a-light

To strike sparks from a knife, hold the tinder still above the knife and strike it with the flint in a shaving action. The sparks will fall downwards on to the tinder. Strike only the back of your knife, not the blade edge.

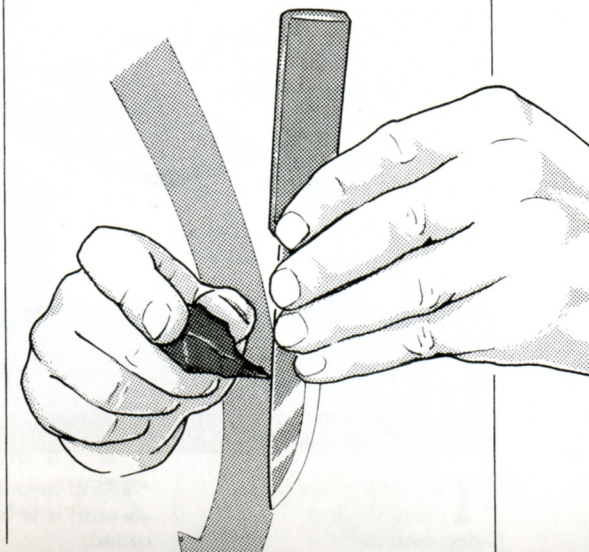

Fire by friction

The truly primitive way to light fires is by friction. This undervalued method is useful, because you are nearly always able to find the necessary materials. Once the equipment has been made it takes only a few seconds to produce fire. Friction fire-lighting does, however, take some time to learn, and you have to provide the initial energy! Mastery of this technique builds confidence and a sense of freedom.

The bow drill

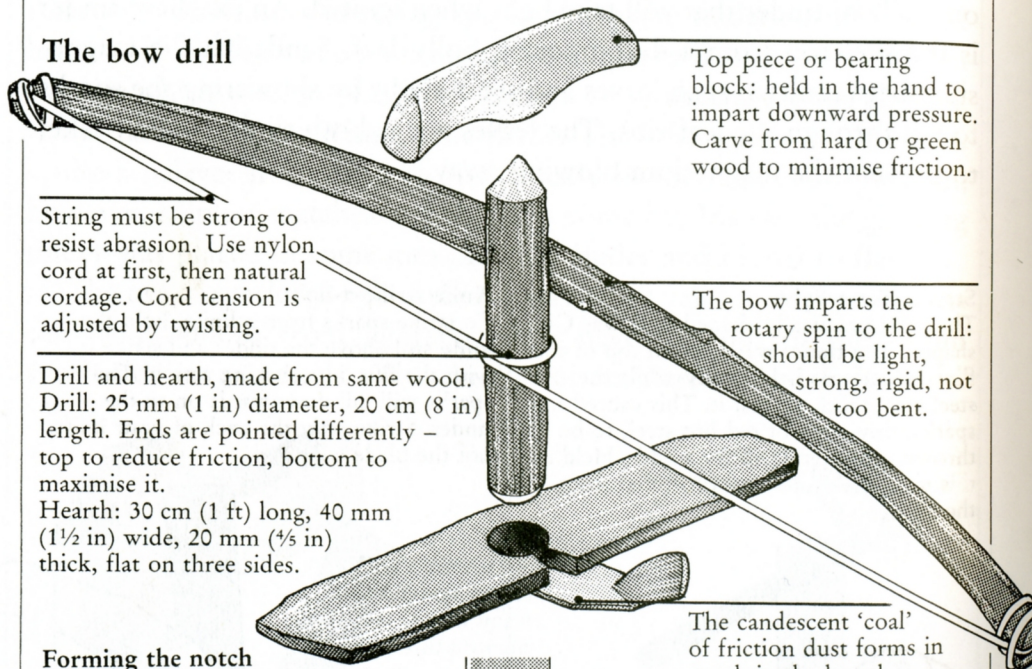

Top piece or bearing block: held in the hand to impart downward pressure. Carve from hard or green wood to minimise friction.

String must be strong to resist abrasion. Use nylon cord at first, then natural cordage. Cord tension is adjusted by twisting.

Drill and hearth, made from same wood.
 Drill: 25 mm (1 in) diameter, 20 cm (8 in) length. Ends are pointed differently – top to reduce friction, bottom to maximise it.
 Hearth: 30 cm (1 ft) long, 40 mm (1½ in) wide, 20 mm (¾ in) thick, flat on three sides.

The bow imparts the rotary spin to the drill: should be light, strong, rigid, not too bent.

The candescent 'coal' of friction dust forms in notch in the hearth. Collect dust in strong leaf or slab of bark beneath notch.

Forming the notch

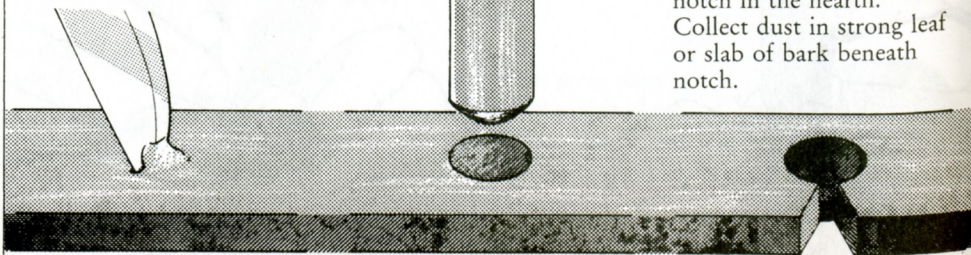

1 With stone or knife, carve shallow depression.

2 Drill into depression until it is black and round.

3 Carve wedge-shaped notch to centre of depression.

Operation



Knee positioned so as not to impede the free swing of your drilling arm

Bearing hand held firmly braced against the left shin, to prevent wobble

Drill twisted on outside of string held vertically; foot clamping the hearth to the ground

1 Drill smoothly, maintaining even pressure until smoke rises from hearth. If string slips, tighten it. Avoid squeaking due to insufficient pressure or dampness. As smoke rises, increase speed and pressure. Smoke should increase in volume, and notch will begin to fill with fine dark brown powder.

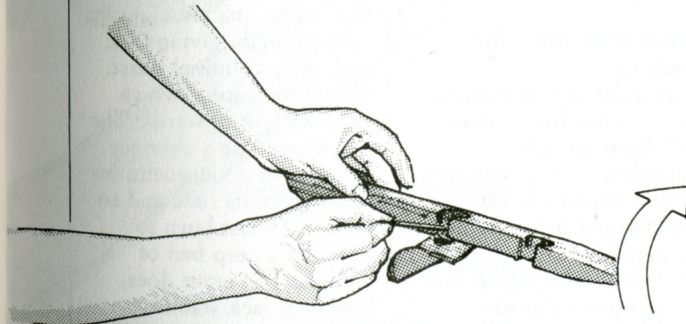

2 With notch full of powder and smoke sustaining itself, stop drilling and roll hearth away while gently holding powder with tiny stick or pine needle. Fan smoking heap of dust with your hand until it darkens and glows red.



3 Transfer the 'coal' now formed to a waiting tinder bundle of the finely teased fibres. With your breath, blow the bundle to life, watching carefully to judge how hard to blow. People are more often too gentle than too harsh.

Suitable woods

Using the correct wood for the drill and hearth is vitally important. This wood must be in the correct condition – dead, dry standing wood, light but still strong, and not punky (pinch soft). Many species can be used; the following are six good woods commonly found.

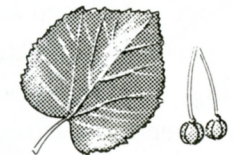

Lime (basswood)



Sycamore



Willow



Birch

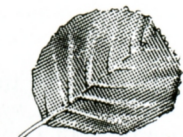

Alder

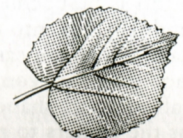

Hazel

Organising your fire

Experience in using fires shows itself most obviously in the way a fire is managed. If your fire goes cold midway through cooking or persistently smoulders, you are not managing it correctly. Looked after properly, a fire is the most versatile provider of light, warmth and cooking heat. Good fire control should become second nature with practice, requiring minimal thought, as you adapt the fire's arrangement – its lay – to your changing needs.

Criss-cross fire – for cooking

Not quite as fast burning as the tepee fire, it does still burn quickly, providing a deep and even bed of embers. It can be constructed before ignition or more usually is simply the method by which fuel is arranged prior to cooking. It also makes a stable 'council' fire – a social camp-fire where ideas are passed around and celebrations take place.

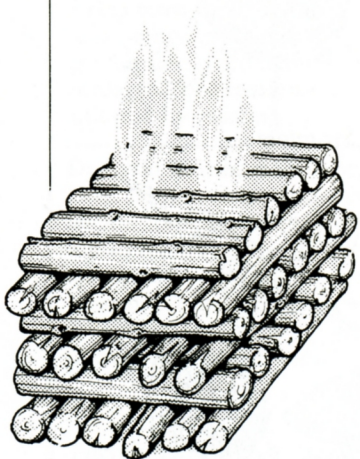

Indian's fire – for the trail

In between meals we need to keep our fire burning efficiently, with a minimum of fuel gathering. On the trail this is best achieved with the Indian's fire. Fuelwood is gradually fed into the centre, long pieces simply burned in half. If you are camping in the same place for a number of days, you can improve the fire by scraping out a shallow bowl-shaped ember pit underneath it. This helps the embers to retain their heat for long periods.

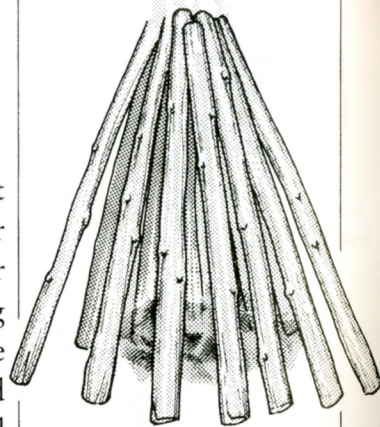
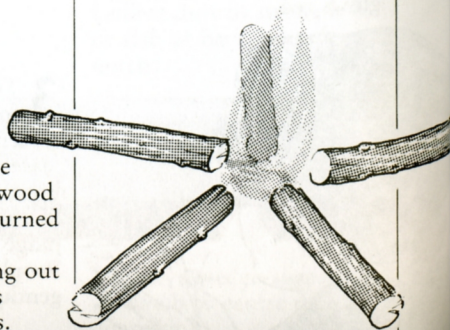

Tepee fire – quick to get going and to burn

This is a fire lay for bad weather or poor fuel, and one of the most popular ways to start a campfire. Arranged in this way the fuel burns quickly along its whole length, giving light and, after an initial burst, very little smoke, which rises straight upwards. The shape acts like a chimney, drawing in good quantities of air from its base and so enabling a fast burn to produce a deep bed of embers. The tepee does, however, lack stability; hence its most common application as the starter for one of the other lays.

Star fire – permanent camp

The natural extension of the Indian's fire is the star fire. The difference between the two is the size of fuel. This fire is built with logs at least as thick as your thigh and often up to 7 m (20 ft) or more in length. The classic star fire is the ceremonial fire of the Cherokee; central to village life and tradition, it comprises four logs pointing north, south, east and west. This lay is an excellent way of maintaining a fire in a permanent camp.

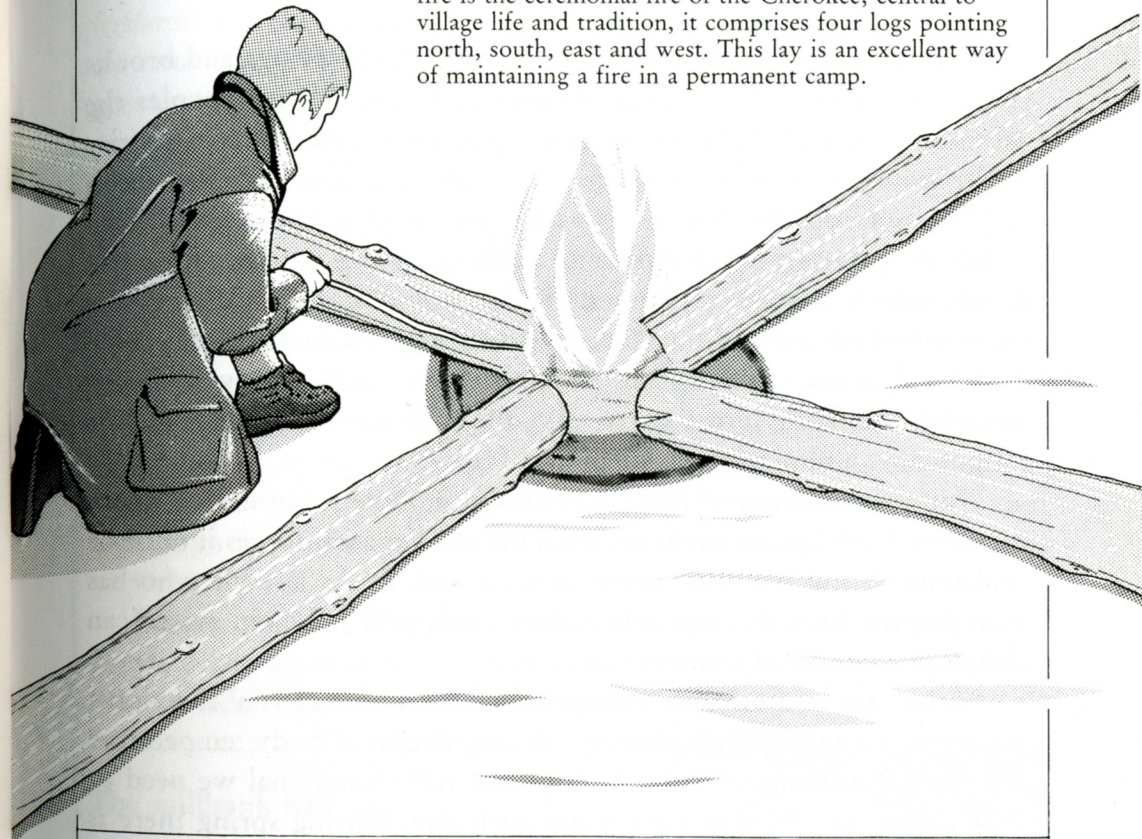

Putting out your fire and leaving no trace

No sight so affronts the eyes outdoors than an old fire site filled with rusting cans and broken glass. When you leave your campsite you have two overriding responsibilities: to extinguish your fire and to leave the site in good order.

Putting out the fire is not difficult, but it must be done thoroughly. The first step is to spread the embers to allow them to cool. If you have already allowed the fire to die down, this is relatively easy. Now extinguish the fire by pouring water on it. To ensure that no underground roots are left smouldering unnoticed, allow the water to soak well into the fire site;

probing with a pointed stick helps. Once the dead embers and ashes are cool, pick them up with your hands and scatter them widely. Brush over the site with a branch and camouflage it to show as little sign of occupation as possible. Take all your rubbish away in your rucksack. If you have been using a ready-made stone fireplace, as commonly found in many backcountry areas, tidy it as mentioned and pile any spare fuel in a dry spot for those who come after you. Make it obvious that you have done your clearing up carefully. Take only memories; leave only footprints.

Cordage

Cordage is a perennial need in the outdoors and a resource that takes time to produce. This is so much the case that the experienced become expert at avoiding the use of string or rope wherever possible. But sooner or later the inevitable has to be faced and cordage needs to be made. Once you start, however, like most people you will probably find it hard to stop; for the act of making cordage is highly enjoyable.

Spring provides the ideal circumstances to gather inner bark fibres. The flowing sap helps to loosen the bark from the wood, which enables you to remove long strips with ease. Fibres for making natural cordage fall into two categories by their usage: fibres best used dry and fibres best used wet; only in a few cases does a fibre fall into both categories.

To list all of the available bark fibres would fill volumes, so we shall investigate here two of the best. Lime bark is best used dry but can be used wet. Willow bark is mostly used wet but can be used dry. In each case it is the inner bark, sometimes called the bast, that we use.

With all cordage materials the gathering and preparation of the fibres take longer than the actual manufacture. For everything but the most quickly made cordage it is best to think of the three stages of gathering, preparation and manufacture as independent activities.

The best cordage is produced from fibres which have been allowed to dry and then are resoaked before manufacture. This is because the fibres shrink more when dried from green than when dried from a resoaked state, which means the weave of the cordage will be tighter due to the reduced shrinkage. With careful manufacture and weaving, you can produce long, even, strong lines ranging in size from fishing line to bridge-building hawsers.

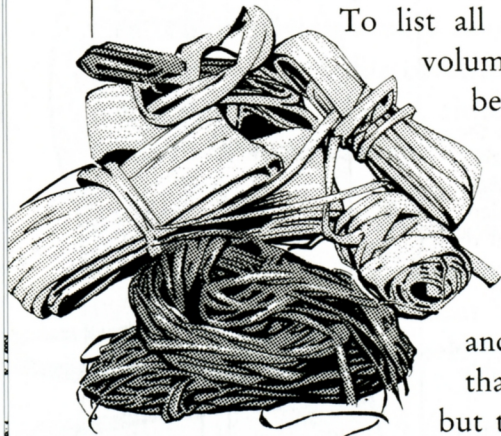

Gathered and dried, bark can be coiled and stored ready for use

CORDAGE

Willow bark

For willow bark you need to find a fallen willow which has shoots rising vertically from its side, or a pollarded willow. You are searching for healthy looking wands about 130 cm (4 ft) long, of finger-to-thumb thickness and with

as few side-shoots as possible. Thus found, cut the wand away cleanly at the base with a saw or sharp knife. A tree found for this purpose will often provide wands for many years if carefully managed.



Lime bark

The name 'lime' is a corruption of the Old English 'linden' or 'line' (meaning 'rope'). The tree is so called because of its reputation for providing valued cordage. Lime bark is easily gathered. The traditional method was to cut away a hand-wide strip from near the base of the tree and then, by pulling down and outwards, to strip off a piece up to 7 m (20 ft) long. However, a sounder method is perhaps to strip the bark from one of the sucker saplings emanating from the tree that lime is so prone to. The sucker can be cut away, leaving a neater scar.



Preparing bark for cordage

Most cordage materials can be pressed into rough service as soon as they are collected, but to make the best cordage you invariably need careful preparation. Always make sure you have prepared enough before you begin manufacture. To avoid getting into a tangle, it is best to organise your raw materials into manageable bundles.

2 Run the point of your knife up the bark so as to split it open down one side. Try to maintain as straight a cut as possible, although you should follow the bark's natural grain.

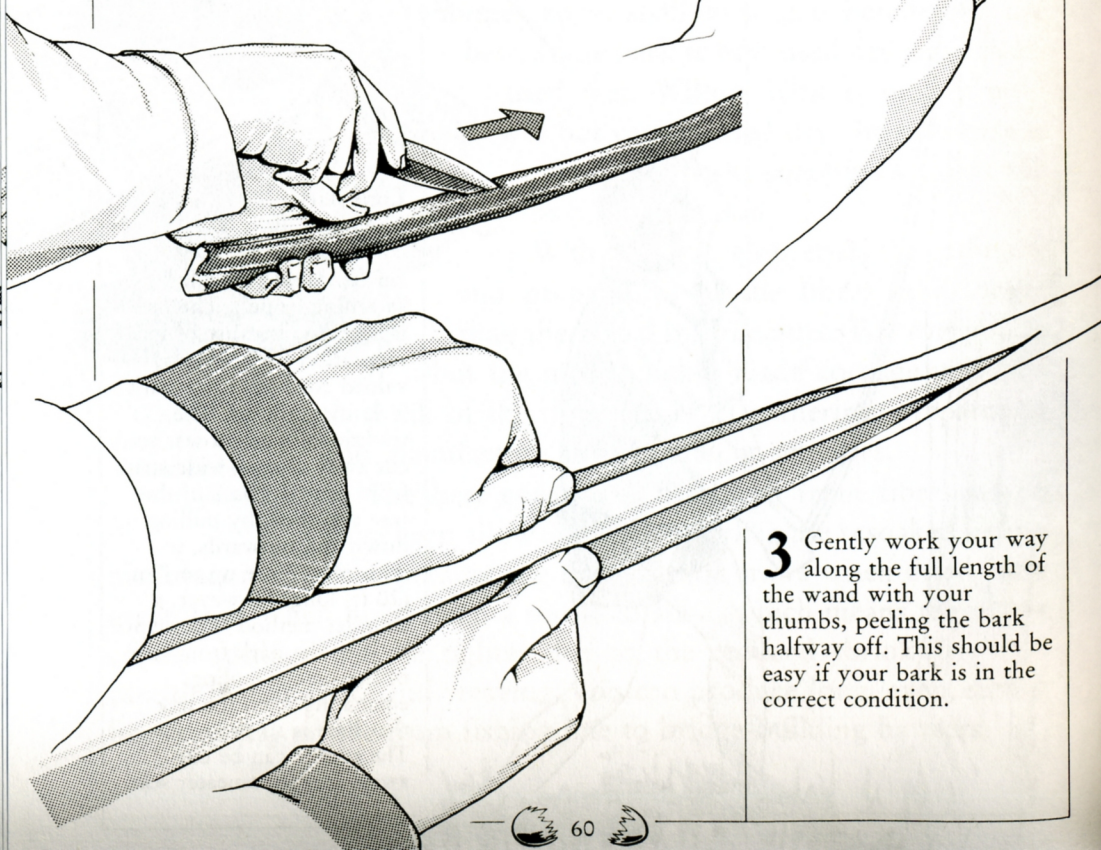

Willow bark

1 Using the back of your knife, scrape away the thin green outer bark, being careful not to break the inner bark. The scrapings can be saved for making a dye (see p.63).

3 Gently work your way along the full length of the wand with your thumbs, peeling the bark halfway off. This should be easy if your bark is in the correct condition.



Lime bark

1 You can peel away the rigid outer lime bark for immediate use when gathered. But the fine cordage you can make from prepared fibres is better: soak the bark for at least ten days, preferably three weeks, in a slow-moving stream.



4 At the thickest end of the wand, fully peel away the bark. Now hold this and lift the wand away from its bark, which should run off easily and neatly. The bark can now be rolled and stored until needed.

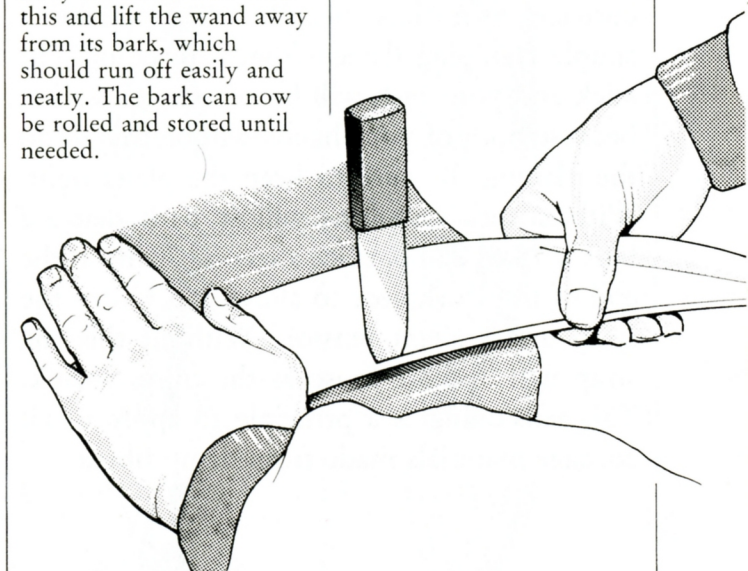

5 Take your fresh bark, or dried bark which you have left to soak overnight, and strip it down. To do this, fix your knife firmly into a log with the edge pointing away from you. Now pull the bark past the blade, strip by strip, to the desired width.

2 After soaking, the bark will have a sweet sickly smell. Now you can strip the inner bark from the crusty outer with ease. Rinse it out and hang to dry.

3 Split the bark down – if necessary, soak it first till it becomes pliable. Lime bark consists of many tissue-thin layers; just separate them to the desired thickness. With enough soaking the fibres should remain reasonably soft when dry.



Laid cordage

This is the most versatile way to make natural cordage. It is easy to do and relatively quick when mastered, and it gives a remarkably strong finished product. You can produce laid cordage as strong as you need it – from light fishing-lines to ropes strong enough to carry you across chasms.

1 Take a good long initial fibre and twist it until it wants to kink. The aim is to round the fibre, making it easier to lay up.

2 Fold the fibre a third of the way along its length. If you fold it in the middle, any joins will be opposite each other – a weak arrangement compared to staggered joins.

3 Holding the fold in one hand, roll both the other ends simultaneously between your thigh and the palm of your free hand.

4 At the end of one full roll, clamp the ends against your thigh to prevent them untwisting and release the end you have been holding; it should begin to twist up. With control this can be persuaded to twist up in a very neat fashion.

5 Grasp the cord again where the twisting ends and repeat the process. With practice your co-ordination will improve and your speed increase. Keep repeating the process until you are within 5 cm (2 in) of the shortest end. Now you will need to join in a new fibre.

Additional techniques

Joining in
Joining in is not difficult. Just lay the end of a new fibre alongside the short end and twist it in, always twisting in the same direction as the thigh-rolling. Keep going. It helps to taper the fibres where they join so as to maintain an even twist.

Spooling
As the length of cord begins to grow, it must be able to revolve freely; if not, it will begin to unravel. The solution is to gather it up on to a free-hanging spool. Two crossed sticks will suffice.

Stronger cordage
Stronger cordage can be made by three methods: first, by using thicker bundles of fibres; second, by doubling up the existing cordage; and third, by laying in an extra strand.

To double up existing cordage, you must twist in the opposite direction to that in which it was originally laid. Cordage twisted originally to the right (Z-laid) must be twisted to the left when doubled (S-laid).

To produce cordage with that extra strand – three-ply cordage – simply add the extra strand or bundle of fibres at the start. With three strands it is a little more difficult and consequently slower to roll on your thigh.

Knots for natural cordage

Bowline – a quick, secure, non-slipping loop at the end of a line.

Double sheep bend – used for joining lines of differing diameters.

Single fisherman's – well suited to joining the more springy natural fibres.

Reef-knot – good for tying off ends, but not a safe knot.

Clove-hitch – simple and versatile, well suited for starting lashings, easily adjusted.

Timber-hitch – quick and efficient to attach to a post or peg.

Fire

With the drier weather you can use the simplest friction fire-lighting technique: the hand drill. The advantage of this method is ease of portability and the fact that it does not require cordage. It does, however, require fitness and a good technique. The drill should be about 1 cm (up to 1/2 in) in diameter and 60 cm (2 ft) long. The hearth should be about 30 cm (1 ft) long, wide enough to accommodate the drill and about the same thickness as the drill diameter. The principle is the same as for the bow drill (see p. 50): drill a depression into the hearth to collect hot friction dust.

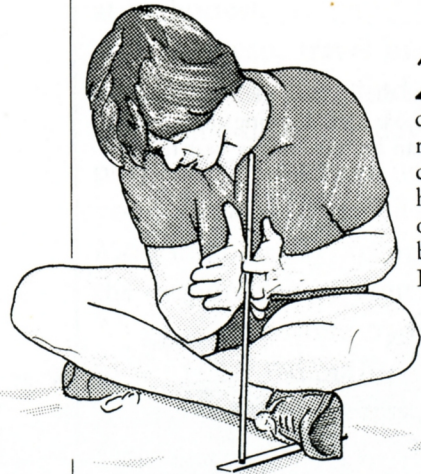

2 As you drill, your hands will move downwards. When they reach the bottom, hold the drill in place with one hand, quickly move the other back to the top, then bring the other hand up. Resume drilling.



1 With the notch cut and a piece of bark ready to collect the dust, spin the drill between your palms, applying a steady downward pressure. Hold the hearth beneath your foot.

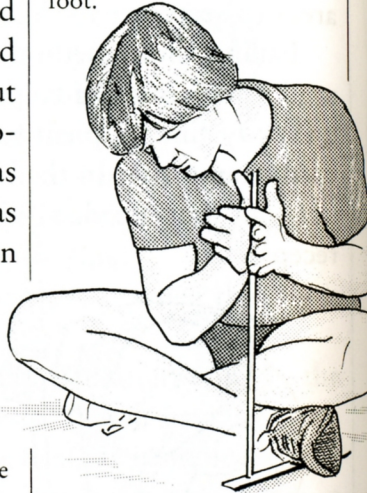

3 Gradually build a coal. Watch the friction dust; you may need to drill faster or modify downward pressure. Once the coal is formed, treat it as for a bow drill (p. 50).

The two-piece drill

It may be that you cannot find a piece of suitable drill wood long and straight enough. A solution frequently used by native peoples was to lash a short piece of suitable wood to a long, straight non-suitable piece: for example, a willow drill-bit lashed into a straight shaft of green elder.

1 Cut the non-drilling end of the bit (overall length 8-15 cm, 3-6 in), to a fine square-sectioned taper.

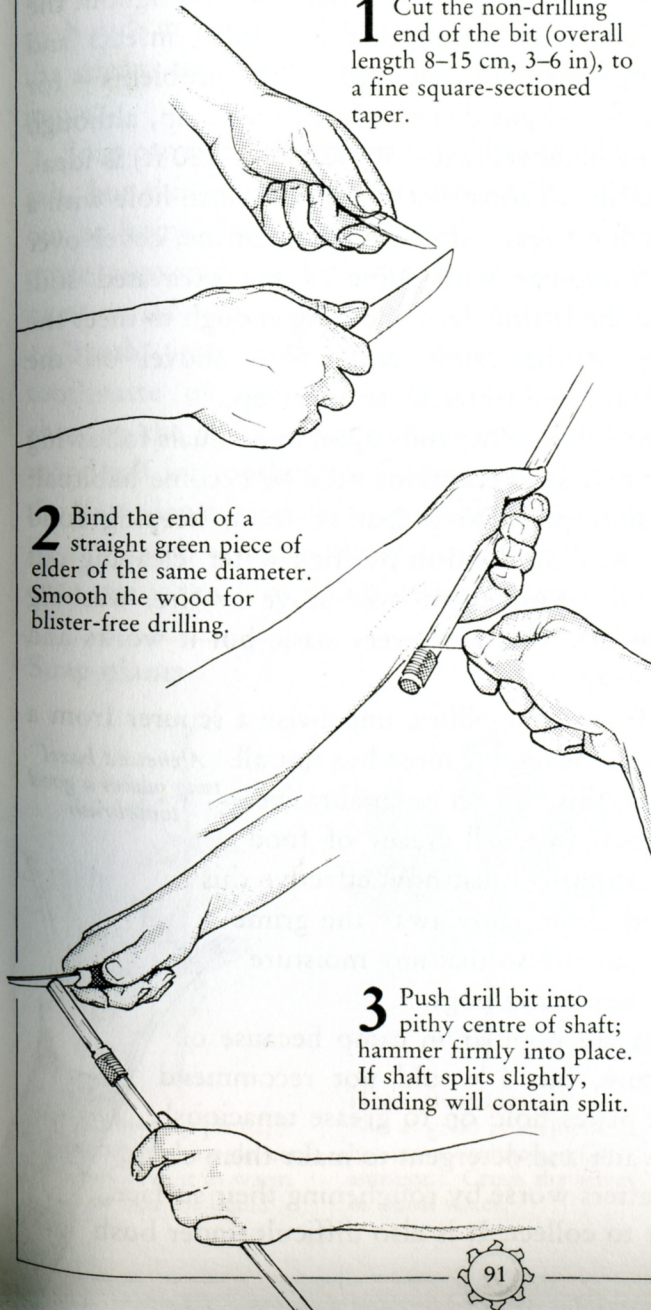

2 Bind the end of a straight green piece of elder of the same diameter. Smooth the wood for blister-free drilling.

3 Push drill bit into pithy centre of shaft; hammer firmly into place. If shaft splits slightly, binding will contain split.

Suitable woods for drill and hearth

The wood for a hand drill set must be perfectly dry. It was usual for native people to gather and season their fire sets deliberately. The following make excellent drills:

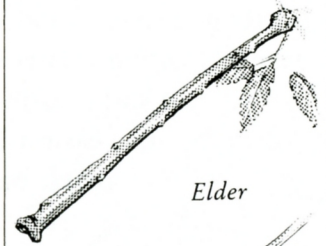

Elder



Mullein

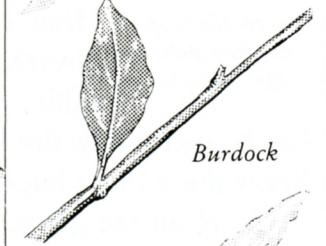

Burdock

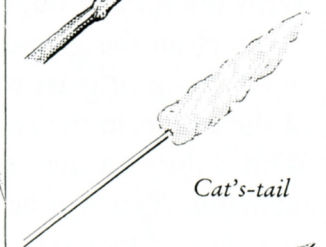

Cat's-tail

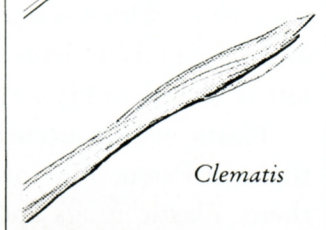

Clematis

Hearths can be formed from any of the bow drill woods but clematis is also especially good.

Fishing

Sadly our rivers today are dirty, poisoned and barren, not a patch on the fountains of life they once were. Over the last century, the steady rise in industry has been paralleled by a dramatic decline in many forms of river life.

Many of our rivers and other waterways are now too polluted by industrial effluents to support the number and variety of fish that once made their homes there. Increasingly, both sea and river fish are reared in the aquatic equivalent of factory farms and every year sees a reduction in the number of wild fish in our streams, lakes, rivers and oceans.

Town and city dwellers are distanced from their local rivers; on the fishmonger's marble slab and at the supermarket counter they can buy different varieties of fish that have been imported from all over the world. But nothing can beat the taste of a 'dead fresh' herring, cooked within hours of being caught, or the summertime flavour of that king of fish, the salmon.

We no longer celebrate the return of the salmon now that our rivers flow with waste being flushed away. Yet every year these masters of the wet world are driven to meet their destiny, guided by senses of direction we can only marvel at.

These fine fish are able to navigate back from the wide expanses of ocean to the shallow gravel-bottomed brooks whence they hatched, exhausting themselves utterly in the drive to fulfil their purpose. Today some have to swim home via the polluted effluence that was once a noble river.

From late summer, salmon return to their spawning grounds

Our ancestors waited expectantly for these silver swimmers and caught them with net, line and spear, taking only sufficient for their needs but enough food to see them through the winter.

Fishing remains one of the few ancient pastimes still carried out both for food and for sport.

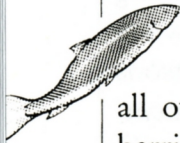

Simple thorns were the earliest fish-hooks

But the elaborate equipment of today's fishermen would have surprised the first anglers; they had no acid-sharpened hooks, intricate flies, sophisticated rods or polyester-fibre line. They had their eyes to watch the fish, the knowledge of where to find cordage and the ingenuity to improvise hooks from thorns.

Even experienced anglers jest that these traditional methods do not work, but they are wrong; for these methods were the foundation of fishing itself, although requiring even more skill than does an angler of today.

Many (although not all) of the techniques employed by our ancestors are outlawed. They require infinite patience, ingenuity and skill. Only poachers dare to use them, for they are unsporting: in other words, deadly effective and efficient.

Tickling fish

Tickling is still carried out on the Falkland Islands as a principal method for catching fish, but it is outlawed more or less everywhere else. It is probably the most primitive of all fishing methods: when you see fish in the water it is only natural to try to pick them out. The secret is to enter the water and ease both of your hands very slowly and gently under the fish; in open water this is very difficult. An easier way is to chase the fish into a convenient eddy pool which can be dammed off, and then you can stalk the fish at your leisure. Gently reach through the water with your hands so as to be able to grasp the fish with a lightning action that prevents its wriggling away.

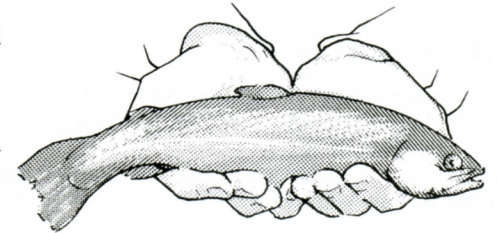

1 Ease your hands very slowly under the fish with your thumbs upwards.

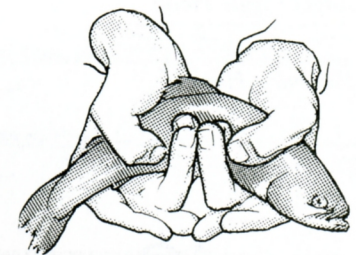

2 In position, grasp and bend the fish, draw it to the pit of your stomach and cast it ashore high on the bank where it cannot wriggle back to the water.

Fishing hooks

Think of fishing and you almost instinctively think of hook and line. Hooks and line are today sophisticated materials maximising strength for size. Improvised hooks – the precursors to modern gear – were made in many different ways from a variety of natural materials, from slivers of bone to thorns. Below are just a few varieties which can be used, fishing usually from a static line.

Feather Baited Thorn Hook

Thames Hook

Simple Thorn Hook

Double Thorn Hook

Treble Thorn Hook

Bone Gorge/Toggle Hook

Thorn Fastening Hook

Small Trolling Hook

Large Trolling Hook

Small Steam Bent Hook

Making a three-barbed hook

What you will need

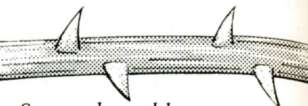

Strong bramble thorns still attached to the bramble



Fine cordage fibres: dried nettle strands (see p. 156)



Some pine resin

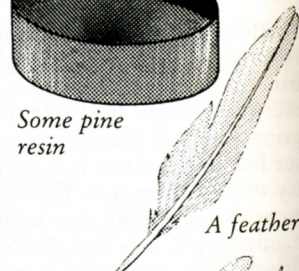

A feather



1 Strip off the feather's blades and retain the stem.

5 Trim off three bramble thorns leaving about 2.5 cm (1 in) of stem fibres above the thorn and 6 mm (¼ in) below.

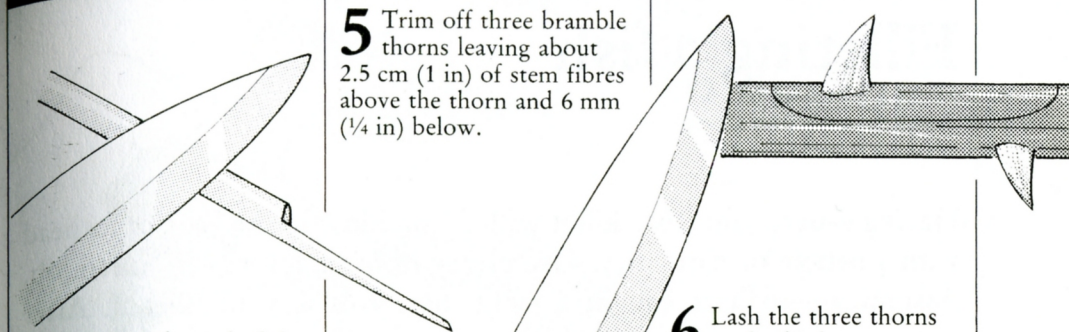

2 Trim the fat end of the feather.

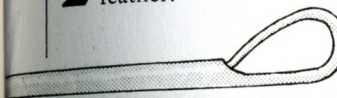

3 Fold over the thinned end and push it into the hollow stem.

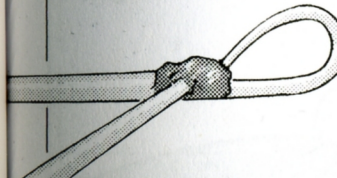

4 Glue the 'eye' you have formed with pine resin so it will not undo.

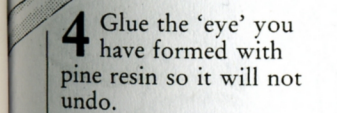

6 Lash the three thorns to the feather stem.

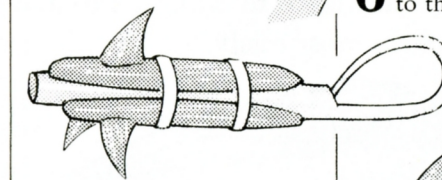

7 Glue in place with pine resin.

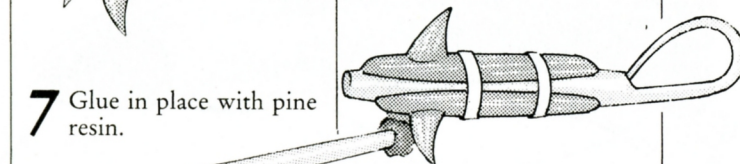

8 Bind thorns in place securely, warming the resin gently to accept the binding and set firm.

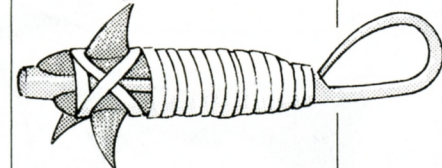

Rigs

Bramble hooks work best with static line rigs such as these. You don't have to be present; leave the rig to fish, but check every few hours.

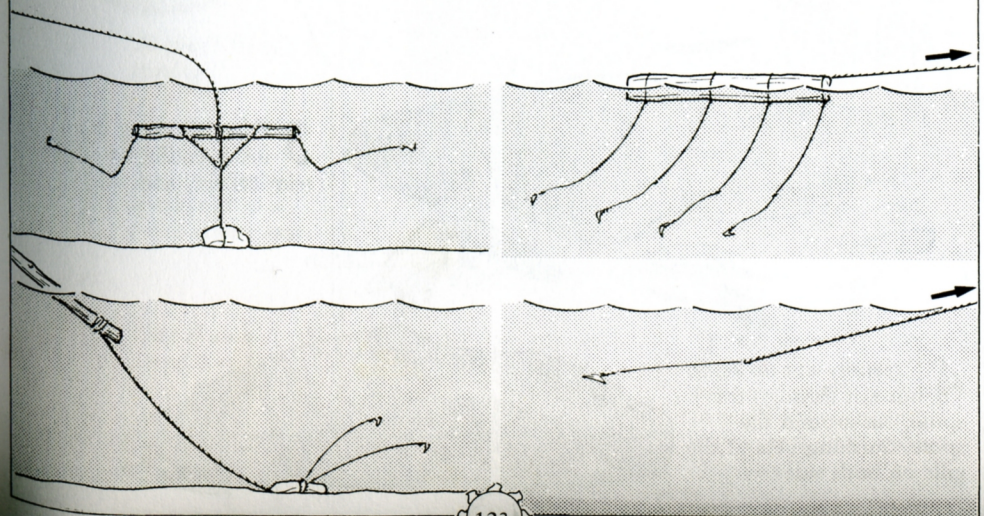

Filleting a fish

Having caught your fish, kill it with a firm blow to the back of its head with a pebble or hard stick. Use plenty of force for a swift, clean job. Assuming you have caught a trout, here is a way to fillet it. After gutting, leave the fish for 6 to 12 hours to allow the nerve endings to die; then it butchers most easily.

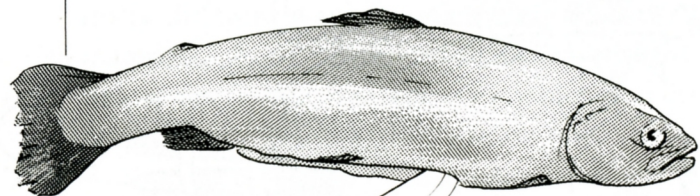

1 Slit the fish from the anal opening to just behind the gills and haul out all the internal organs.



2 Thoroughly clean and wash the flesh.

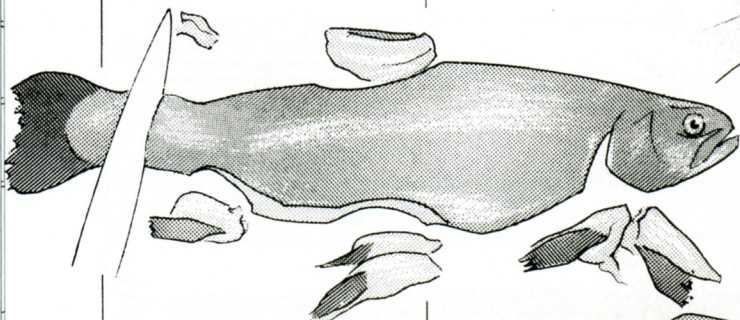

3 After allowing the nerve endings to die, trim off fins and tail.

4 Carefully cut down to but not through the spine; cut around the spine, finishing behind the gills on both sides.

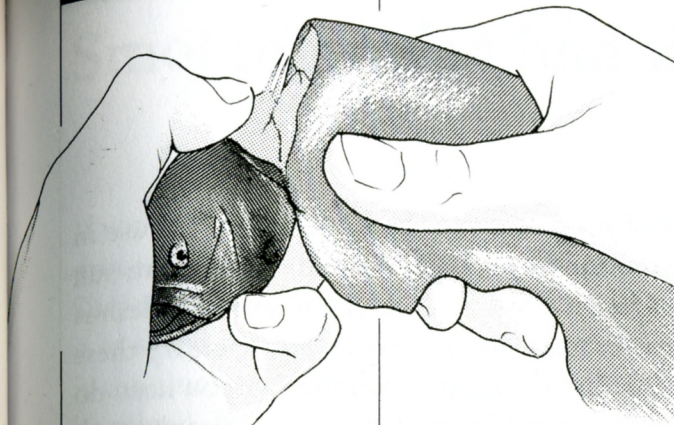
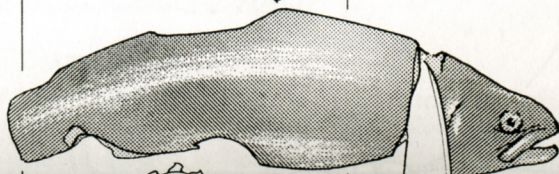

5 Insert your thumb along top of the spine and begin to pull it away from the flesh gently but firmly.

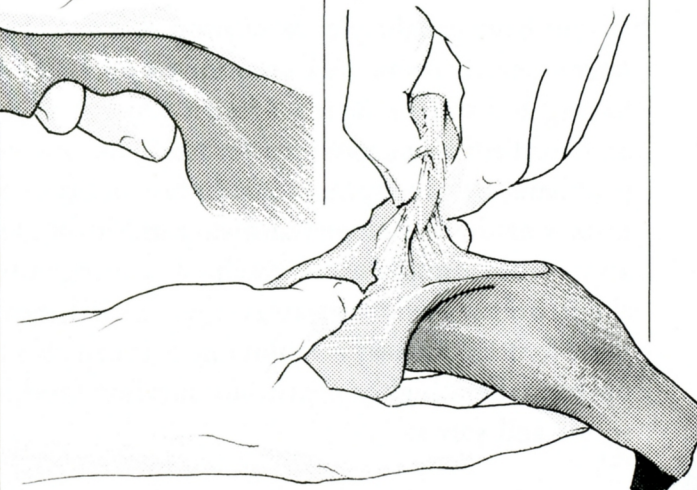

6 If it helps, invert fish and maintain slow, gentle pull. Ribs should come out cleanly with the spine.

Preparing a filleted fish for cooking

What you will need



30 cm (1 ft) of cordage

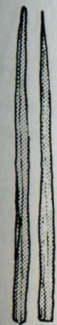

Two pencil-thick sticks one hand-span in length, sharpened to a point at one end

One thumb-thick wand 1 m (3 ft) long, split for half its length

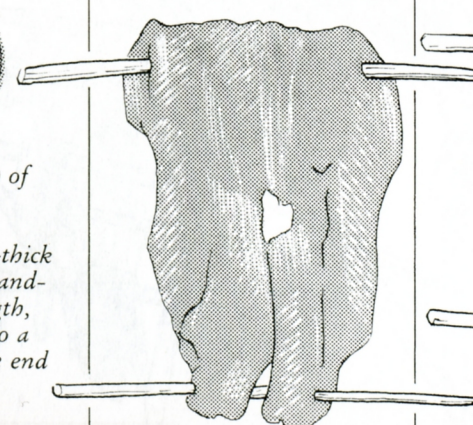

1 Skewer fish top and bottom to hold it open.

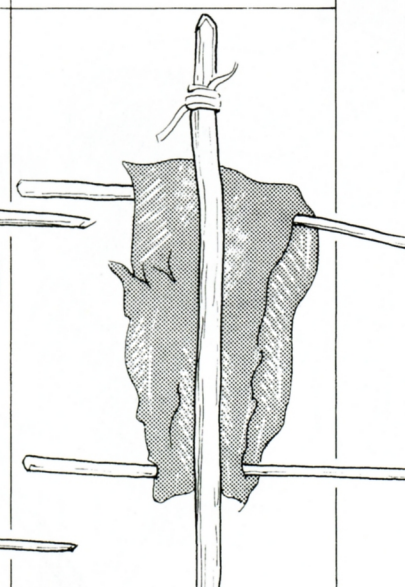

2 Slip skewered fish steak into split stick and tie split at top. Prop at an angle above an ember fire to cook until golden. Delicious!

Shelter

Once the cold weather of autumn really takes hold, you need to start thinking about using winter shelters, particularly those which incorporate a fire. The classic cold-weather shelter is the open-fronted lean-to, which relies on a fire to provide warmth. Open down one side, it is designed to allow the fire's heat to be reflected into the shelter and down on to you from the roof. The sloping roof is easy and quick to construct but must overhang you far enough to prevent rain or snow landing on your bed! To make the best use of this shelter, you need the correct type of fire and bed.

Well-constructed bed



Long log fire

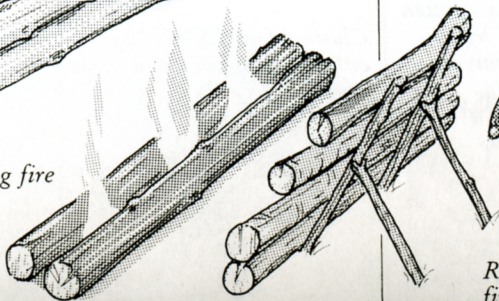

Reflector behind fire



Brush covering for thatching

A few metres (yards) of cordage



Rafters 250 cm (8 ft) long

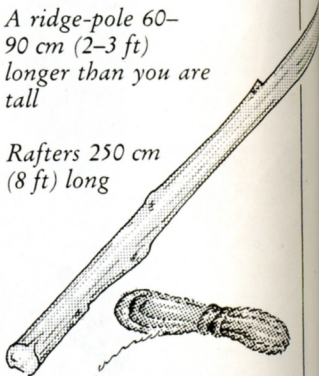

A ridge-pole 60-90 cm (2-3 ft) longer than you are tall

Two diagonal props 250 cm (8 ft) long

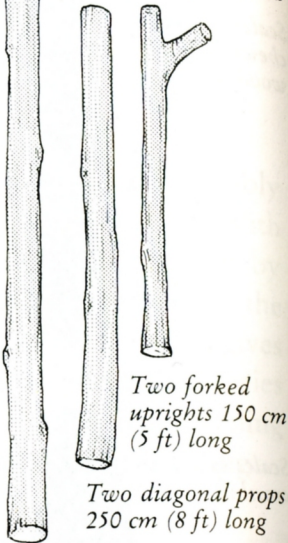

Two forked uprights 150 cm (5 ft) long

What you need

1 Set up ridge-pole with uprights and diagonals; if necessary lash with cordage. Framework must be strong, stable and sited on well-drained level ground.

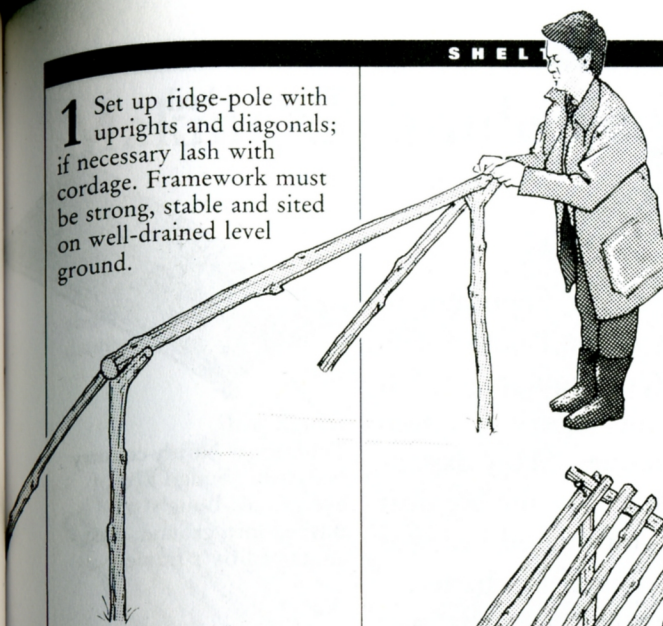

2 Lean rafter logs up against ridge (should not require any lashing). A neat, even job will aid reflection of fire's heat. Angle roof between 45° and 60°.

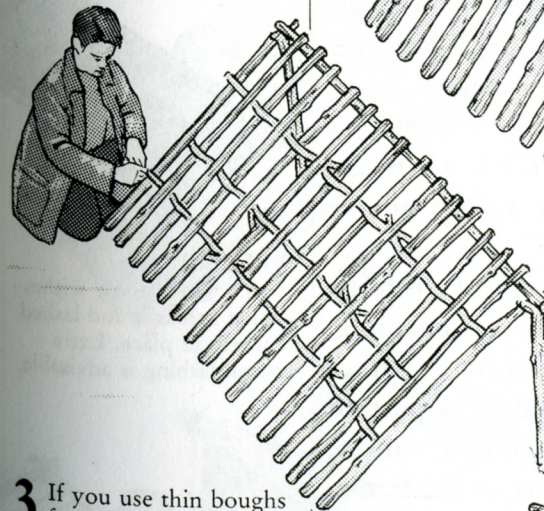
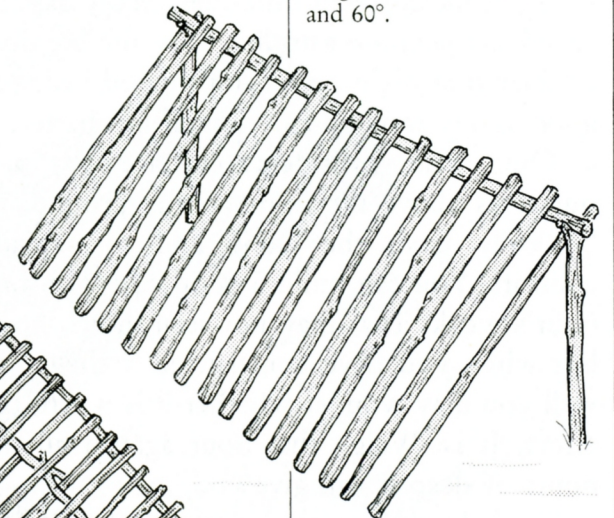

4 Starting at ground level, thatch roof neatly with overlapping boughs or branches. Construct end walls to close off drafts on three sides.

3 If you use thin boughs for rafters, interlace some cross-members, lashing as necessary to diagonals of main frame.

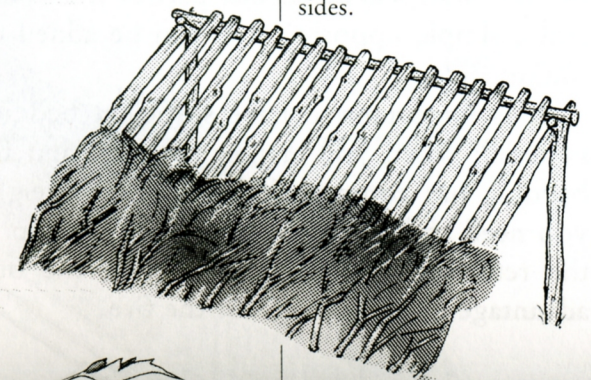

Bedding

Few aspects of camping are as important to morale as a good night's sleep. This is easily provided by modern camping equipment; but if you are doing without this luxury you need to know the correct techniques. Many experienced campers are astounded by the comfort of their first night on an improvised bed – as good as any modern mattress, if not better!

Our main considerations are to raise ourselves above the heat-sapping ground, to be away from the damp and to provide comfort. You can build a good bed with one hour's work. That may not seem much now, but when you have constructed a shelter as well you may wonder whether it is worth the effort. It is. Weigh that hour against all the hours of sleep it will give you.

To help reduce the amount of bedding material needed, and to prevent it spreading, you need to enclose the bed by a frame, either specifically made or incorporated as part of your shelter. With the open-fronted lean-to, the rear wall will act as one part of the frame, and a simple opposing wall can be added on the fire side.

It is important to have sufficient bedding material: when you are on the bed, and the bedding has compressed under your weight, you need to be just at the level of the top of the retaining wall. This gives you the best advantage of the warmth of the fire.

Types of bed

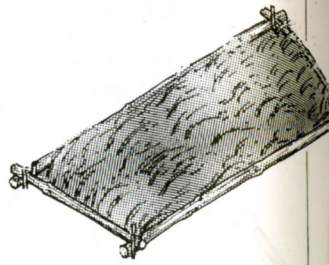

Bough bed
Traditional North-country bed, using bough tips of evergreens. Boughs are pushed into ground. Best contained by a frame.

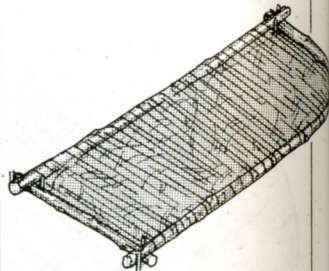

Withe bed
Frame with willow withes passed across it and lashed securely in place. Extra central lashing is advisable.

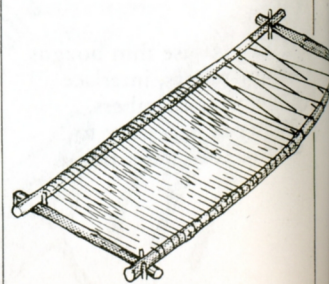

Rope bed
Improvised hammock-like from climbing rope or grass rope.

Making a simple bed

1 Lay crosswise moisture barrier of dead logs about 5 cm (2 in) in diameter, as wide as bed.

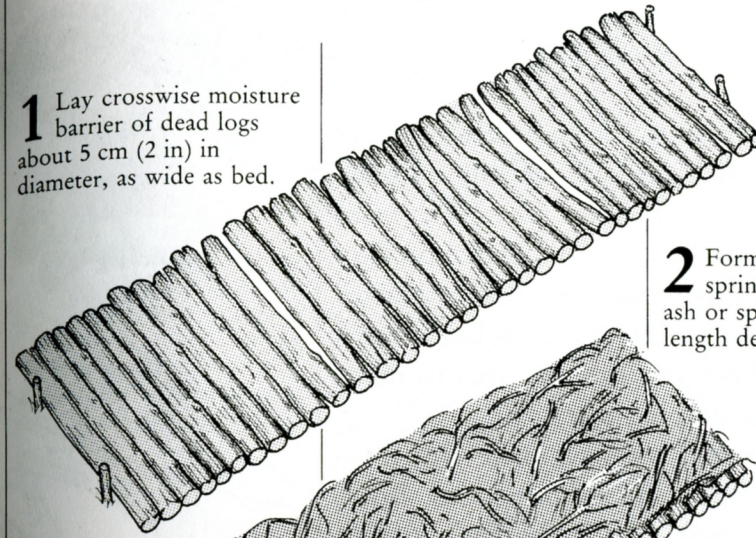

2 Form mattress from springy branches (e.g. ash or spruce) to arm's length depth.

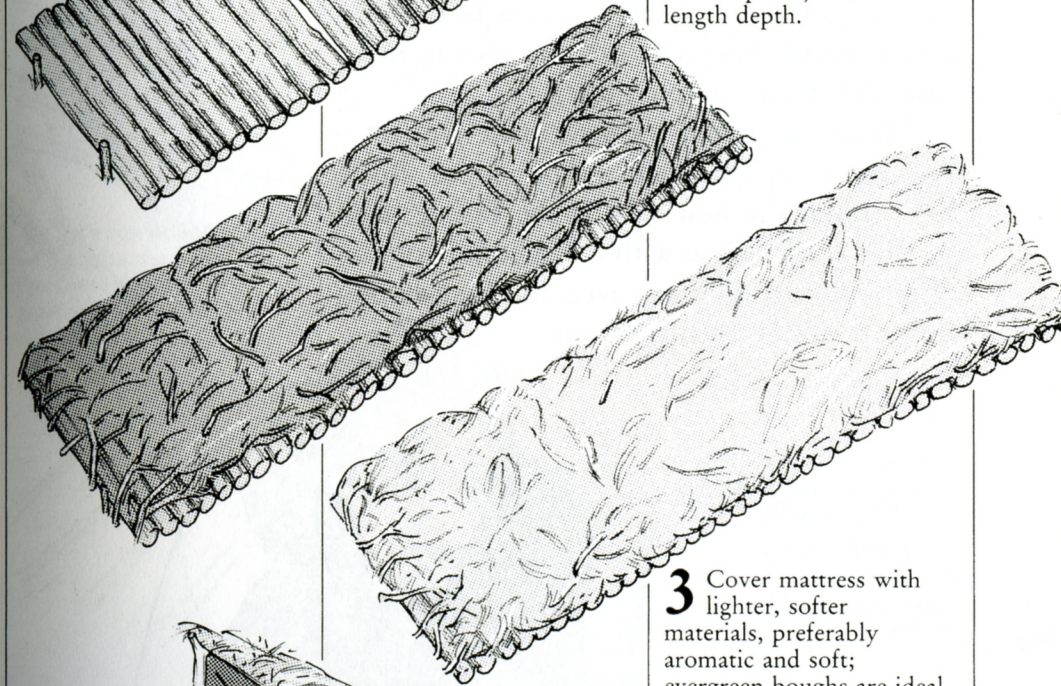

3 Cover mattress with lighter, softer materials, preferably aromatic and soft; evergreen boughs are ideal.

4 If bed is incorporated in an open-fronted lean-to, contain it with a low retaining wall.

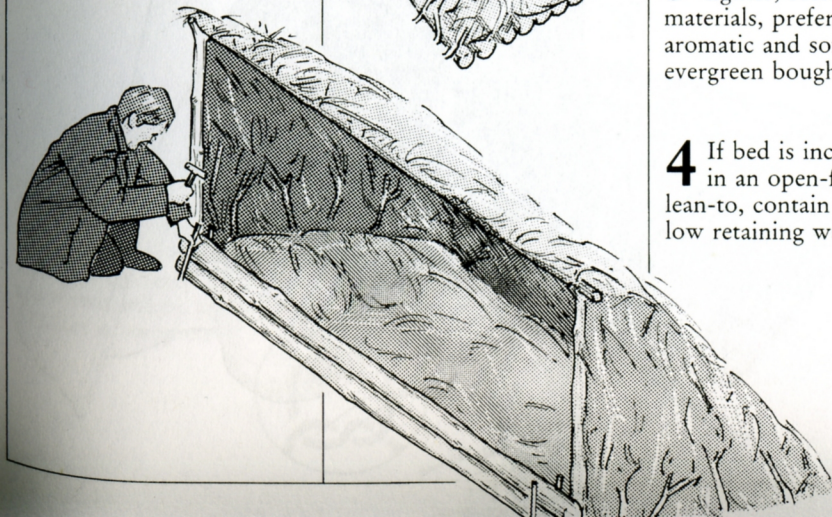

Duvet

A shelter and a bed will keep you warm, but without a covering you are unlikely to sleep soundly. Making a blanket or duvet from natural materials is not as difficult as you may think. A host of dry materials such as grasses can be woven into a duvet that is both warm and practical. They can even be used to make roof covers and sleeping mats.

There are several ways to make a duvet – you can even build a makeshift loom. But I have found the best way is the simple hand method shown here; with this method you can fashion a very tightly woven and long-lasting duvet that may even shed rain.

Your bush duvet can double as a makeshift portable shelter

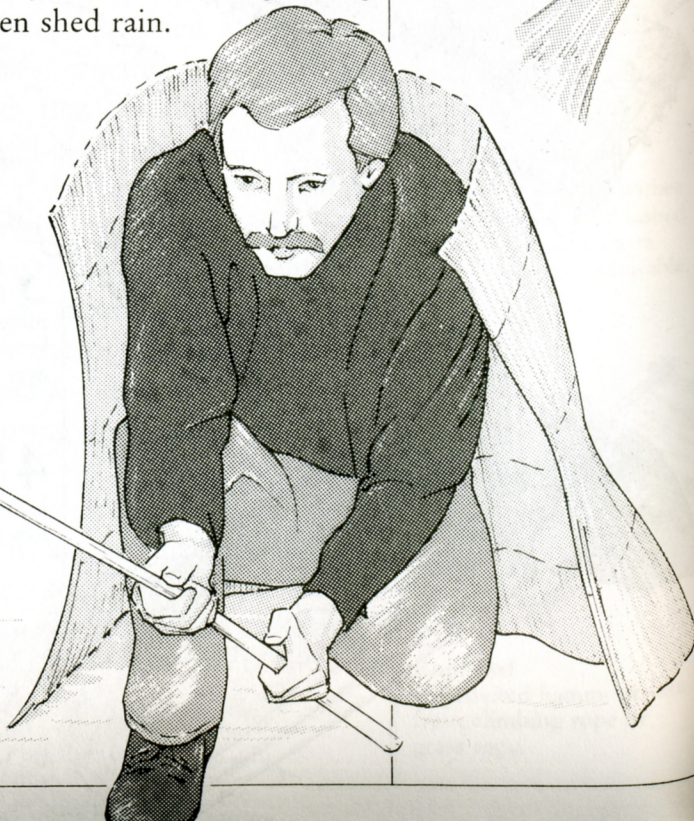

What you need

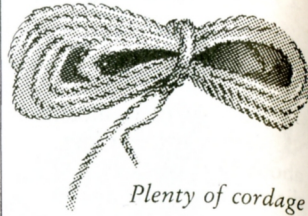

Plenty of cordage

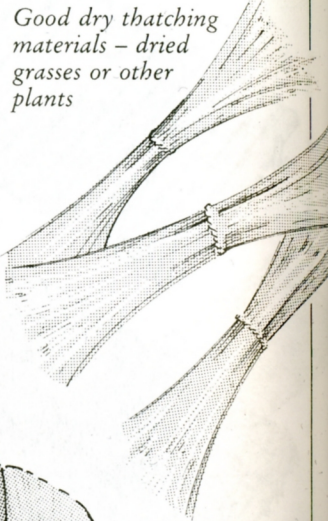

Good dry thatching materials – dried grasses or other plants



1 Hammer two pegs into the ground the length of blanket to be woven. Tie cordage between them.

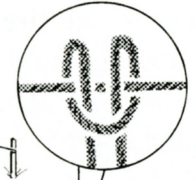

2 Join doubled lengths of cordage to the string, twice width of blanket to be woven.

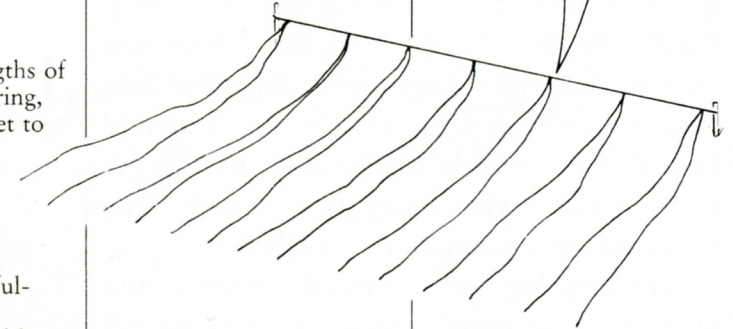

3 Between doubled lengths, tie handful-thickness bundles of grasses. Pull overhand knot tight to keep weave close.

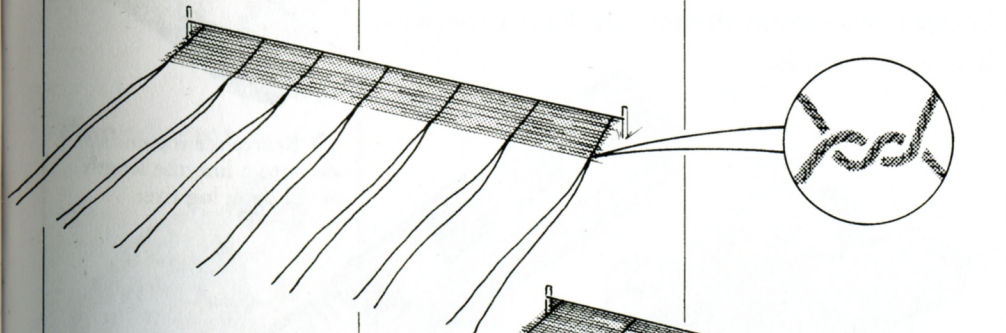

4 Repeat step 3 until duvet is full width. Secure ends of binding strings with reef-knot, free from two stakes, and blanket is complete.



Group shelter

Winter is often a time when youth organisations work indoors, but what an experience they are missing out on! The group shelter offers comfortable winter woodland camping that no tent can ever match. Here you can recline, listening to the wind howling and watching it swaying the trees, but not feel its bite, as you are comforted by the warm flicker of your fire. Being circular, the shelter encourages social dialogue and friendship.

The shelter should be as small as possible to save on materials and to keep in the warmth. The diameter of the central opening must be small enough to trap the heat of the fire without becoming a safety risk: usually this opening is made too large. A doorway is important to make the shelter function like a chimney, drawing the smoke straight upwards. Either side of this entrance, set in a good store of wood to keep the fire fuelled through the night; and work out an all-night watch rota to ensure the fire is maintained. Your shelter will provide a good home for weeks if need be.

What you need

Six forked uprights
1.5 m (5 ft) long



Six major diagonal supports
2.4 m (8 ft) long

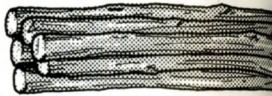

Six 2.4 m (8 ft) ridge-poles



Rafter brushwood

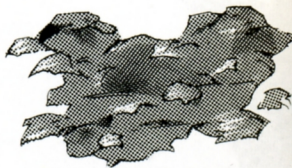

Leaf litter or similar for thatching

The group shelter gives you the warmth and comfort of a cabin for a fraction of the effort

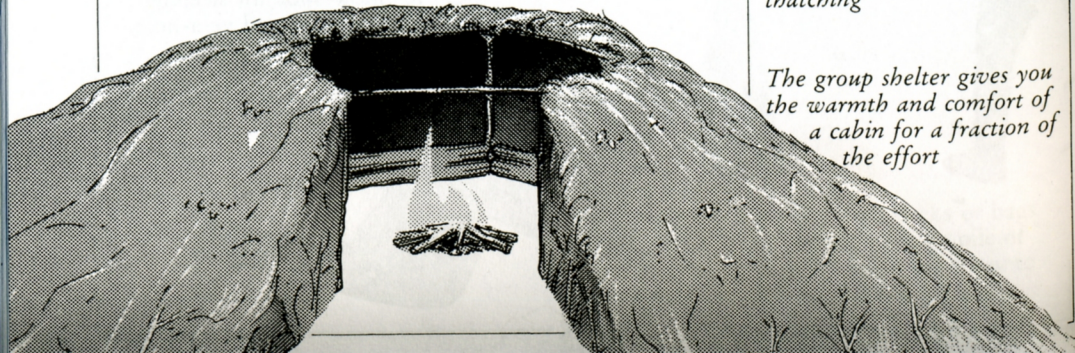

1 Lay out ground plan, dig bowl-shaped fire pit and set upright supports into ground not too far from fire.

2 Fit ridge-poles; try to find forked poles to avoid use of lashing materials.

3 Fit diagonal supports; shelter framework should be virtually self-supporting and very strong. Set two uprights to mark doorway.

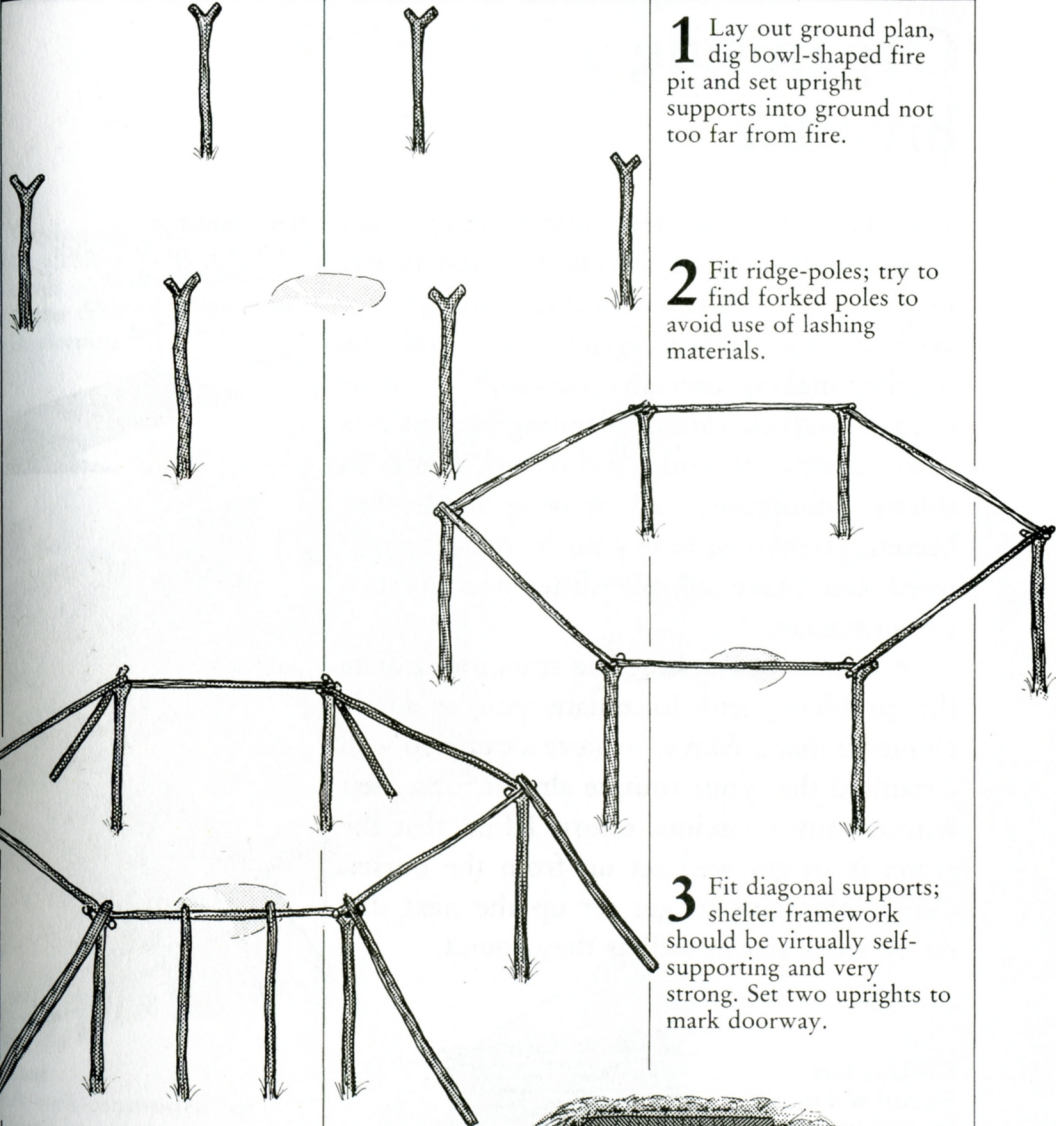

4 Thatch as for spring shelters (p. 39), with rafters tightly packed and covered with leaf litter, all anchored with light brushwood.

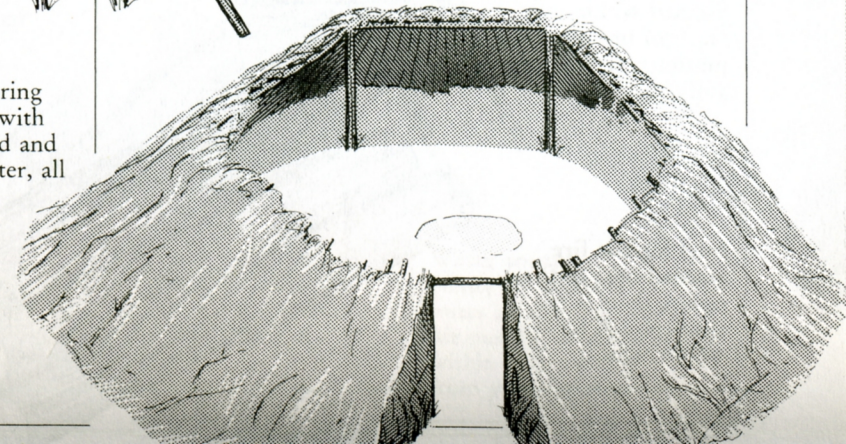

Organising a bivouac

The experienced winter camper knows that organisation is the key to comfort and safety. In primitive circumstances this is doubly so. With daylight hours against you, and the weather making excessive demands on your energy reserves, careful planning can make a vast difference to your level of well-being. In snowy conditions, just moving about can become strenuous; how your bivouac is organised can make all the difference in such circumstances.

Start out by assessing the situation: isolate the problems and formulate your plan to eliminate them. Aim to achieve a camp so well organised that your routine almost runs itself without any conscious effort. I find that the secret is to get well set up from the outset. Good intentions to get set up the next day rarely work out as well as they sound.

Cooking fuel

Stacked within easy reach of fire ready for morning; try to keep in a dry place.



Fuel for the fire

Stacked near to fire – ensure there is more than enough for the whole night.

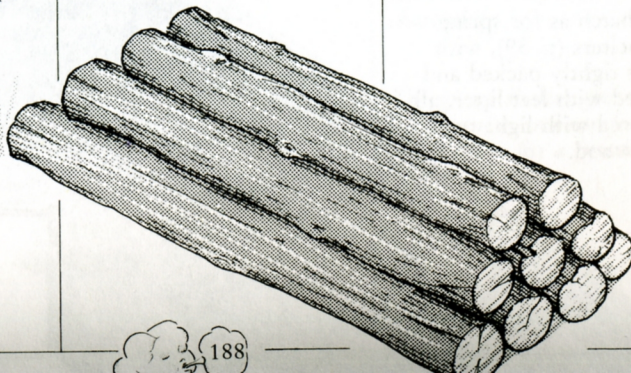

Wind direction

Set lean-to (p. 148) with wind behind and at slight angle – to keep shelter warm but smoke-free.

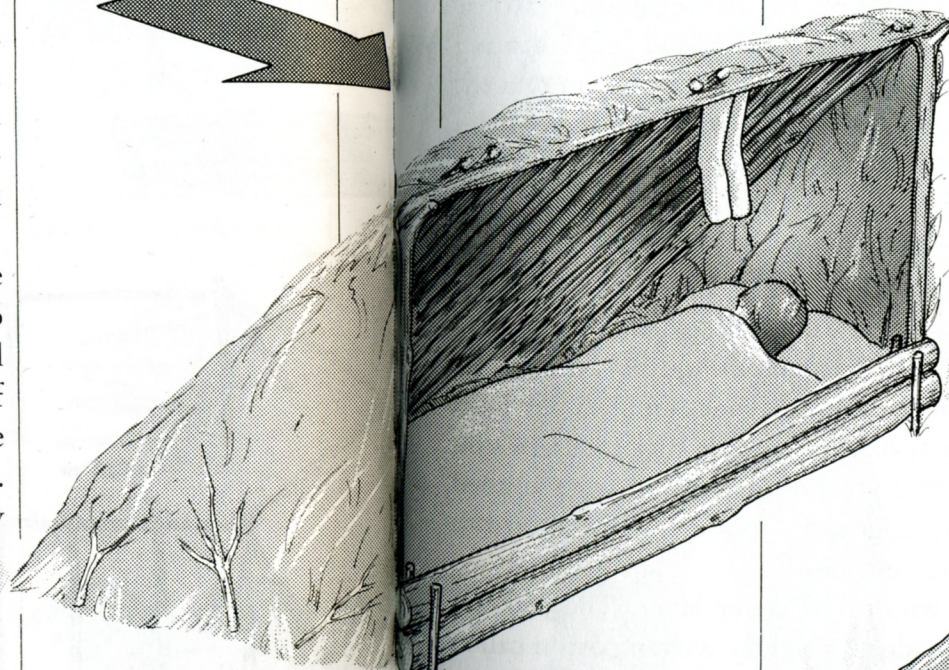
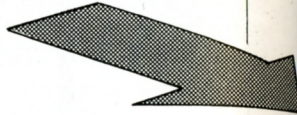

Drying clothing

Dry clothing slowly in eaves of lean-to – far better than body-drying in sleeping-bag.

Collecting water

Snow can be slow to melt; make a snow-melting bag and place in warm air between shelter and fire.



Bed

A well-constructed bed gives sound sleep; as days pass, top up insulation to compensate for compression.

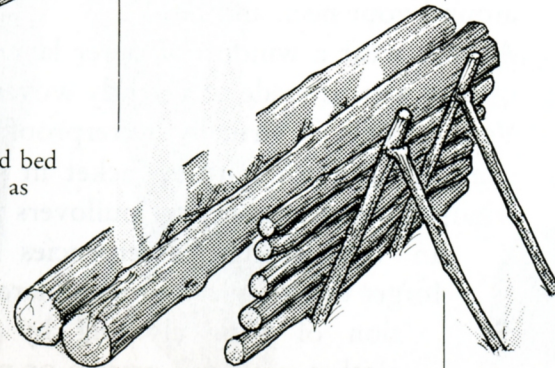

Fire

Organise fire to burn slowly; the long log fire (see p. 154) is ideal.

Fire reflector

A reflector placed behind fire (p. 52) is a must at this time of year.

Water source

Plenty of available water or sufficient snow for melting needs to be within easy walking from your bivouac.

Transporting fire

Having managed to start your fire, it is also possible to carry it with you as you travel about. There are several methods that have been used by tribespeople in different parts of the world, ranging from the Aboriginal method of carrying a burning log and swinging it to keep it alight to wrapping a coal in a fireproof leaf, a practice that is favoured by the African Pygmies.

A carried fire usually helps to keep you warm as you go about your tasks. It can be made to smoulder and thereby keep away insects. Most important of all, it is a portable morale-booster when conditions are harsh.

The best material for keeping a fire smouldering is dried bracket fungi like those used to make amadou (p. 175). Failing that you can make a giant tinder cigarette which smoulders slowly.

If you also carry two fist-thick bundles of fine kindling wrapped up in fibrous grasses, you have the makings of an instant fire as and when you need it.

Smouldering bracket fungus

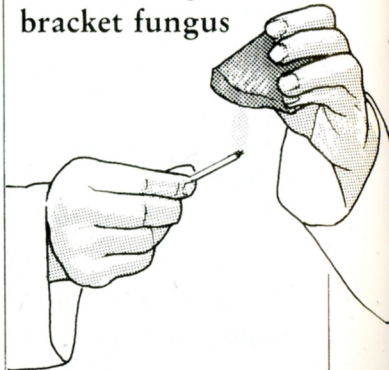

1 Light a broken bracket fungus; it should glow and smoulder with a pungent aroma; try e.g. *Ganoderma adpersum*.

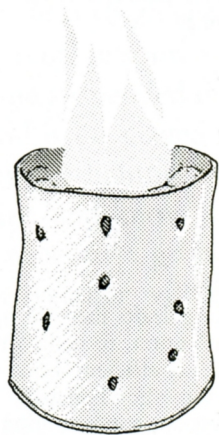

2 Carry smouldering fungus in improvised bark or wood container or old can punched with holes; surround tinder in moss to give insect-repelling smudge.

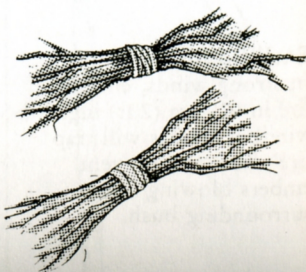

Faggots

Collect two fist-thick bundles of fine kindling broken no shorter than 30 cm (1 ft) in length. Wrap these bundles with dried grass or bark. When you need a fire, prepare a small platform, place your bundles together on top of it with a small amount of tinder beneath them and ignite. The whole operation need not take more than a minute.

Smouldering fire tube

1 Take piece of long sheet of bark and lay finely teased grass or other fibrous tinder down middle.



2 Roll tube up and secure with ties every 8 cm (3 in) or so down length.

3 Drop large enough ember into end to start tube smouldering.

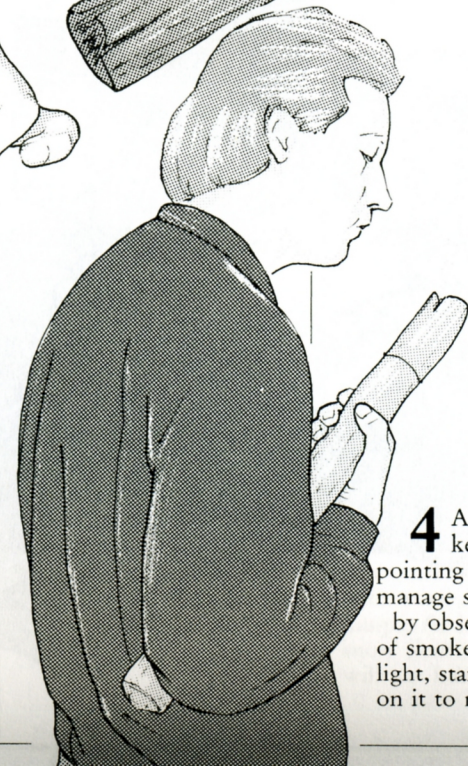

4 As you travel, keep tube pointing into breeze; manage smoulder by observing density of smoke; if it catches light, stamp out or spit on it to regain control.

Cordage

In winter, cordage materials are generally less available than at other times of year. Most barks are locked tight to the trunks of dormant trees, and the majority of fibre plants are woody and brittle. Our native ancestors would certainly have stored cordage materials from other seasons to weave with through the long winter nights. However, there are still one or two cordage resources that we can make use of.

Finding cordage materials in winter more than in any other season teaches you to be adaptable – to use your eyes to search out fibres and your hands to test them. Many of the lifeless woody plant stems will still yield cordage if soaked in warm water and carefully and patiently worked. Take a hike to see what you can find.

Withes

Young shooting stems of trees, often found as suckers rising from roots of a mature tree, are easily gathered now the undergrowth has died back. A strong cordage resource with a variety of applications: ash and willow are exceptionally good.

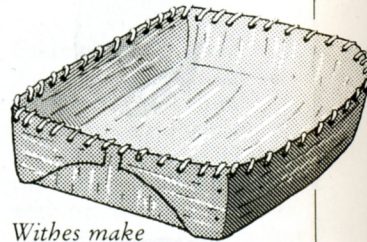

Withes make excellent cordage for sewing together basketry and birch-bark canoes



Rootlets

Unless the ground is frozen, rootlets can be gathered. Similar in handling to withes, they can be used as wire for fastening. Can be gathered in greater lengths than withes – search in swampy ground. Use hard wood rootlets (e.g. oak and beach) or evergreens, especially spruce.



Clematis

Where the clematis grows well it takes on prodigious proportions. During the second half of winter the outer bark seems to shed naturally; this hairy tangle is excellent tinder but can also be used to make strong ropes.

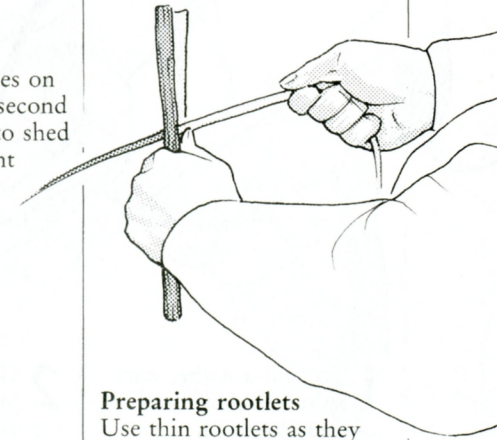

Preparing rootlets

Use thin rootlets as they are; split thicker ones. All are best with their bark removed by first boiling and then stripping through a split stick.



Clematis rope

Withes cordage

Withes and rootlets are slightly different in their handling characteristics, as you will discover. However, they can be prepared in the basic same way. You can use both whole or split, and both are made pliable by boiling, although this is particularly true of rootlets, which benefit from soaking in a concentrated wood-ash solution. In a hurry, simply steam them under your fire for a few minutes.



Twisting
Withes used for quick bindings have fibres loosened by twisting while still attached to the ground; this increases pliability.

Plaiting
Plait withes in pairs to facilitate joins, producing stiff but strong flat ropes.

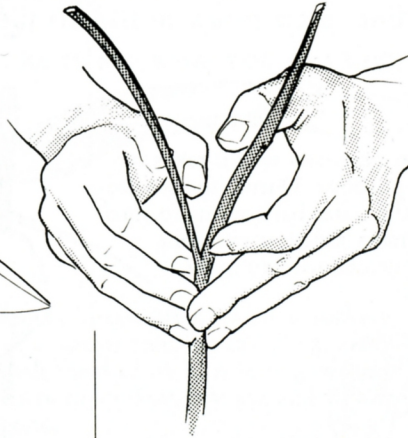
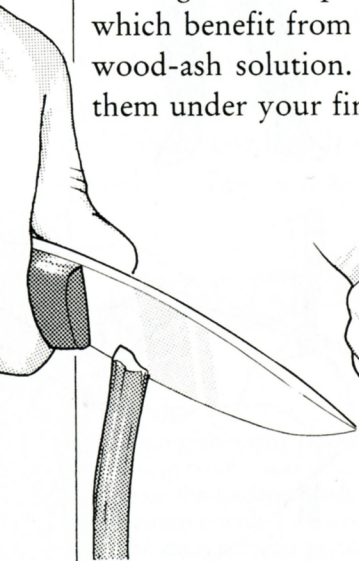
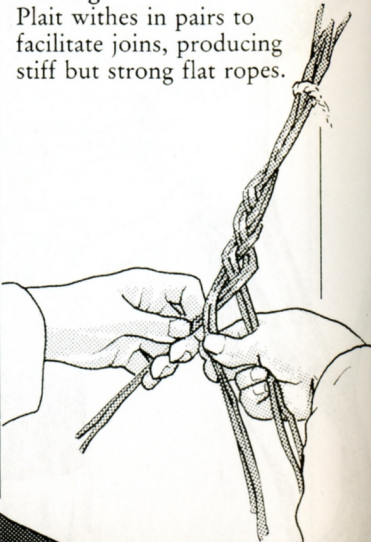

1 To split a with, start split with knife and continue by hand.

2 Control split and prevent it running off to one side by bending thicker side to greater degree. With practice you can split withes in three using teeth as a third hand.

Some ways to split withes

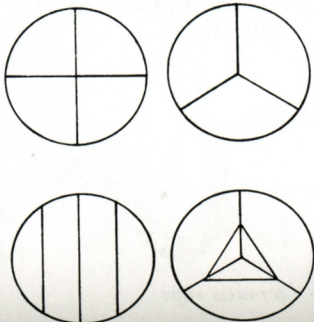

Clematis cordage

Clematis needs little more preparation than hand-separation of the fibres. It tends to be a somewhat messy material to work with but produces excellent cordage. The beauty of this material is the speed with which it can be gathered in quantity.

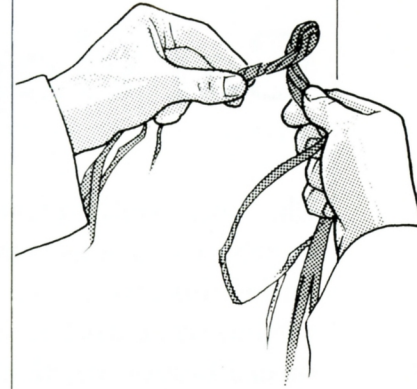

1 Twist up fibres until they kink into a strand about 2.5 cm (1 in) in diameter.

2 Hold tight in left hand, clamping twist tightly under thumb.

3 Twist fibres of strand furthest away from you twice away from you; at end of second twist, hold strand to prevent unravelling.

4 Draw strand you are holding twisted over strand nearest to you and interchange them.

5 Repeat and continue until rope is of desired length. Add new fibres as for thigh-rolled cordage (p. 58).

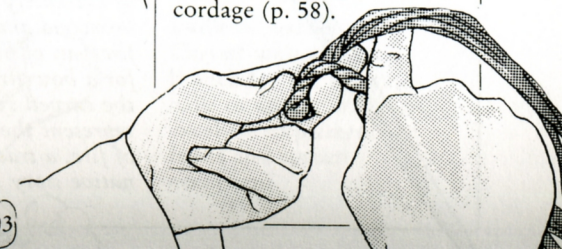
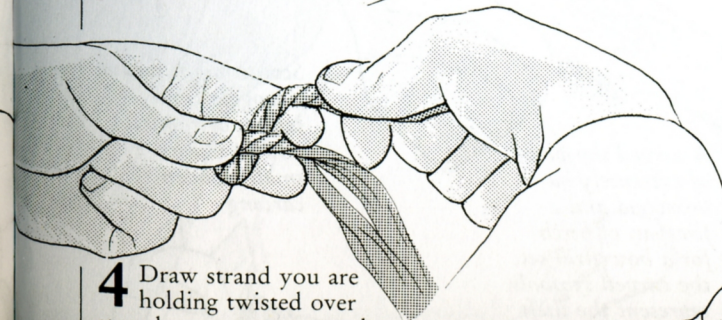
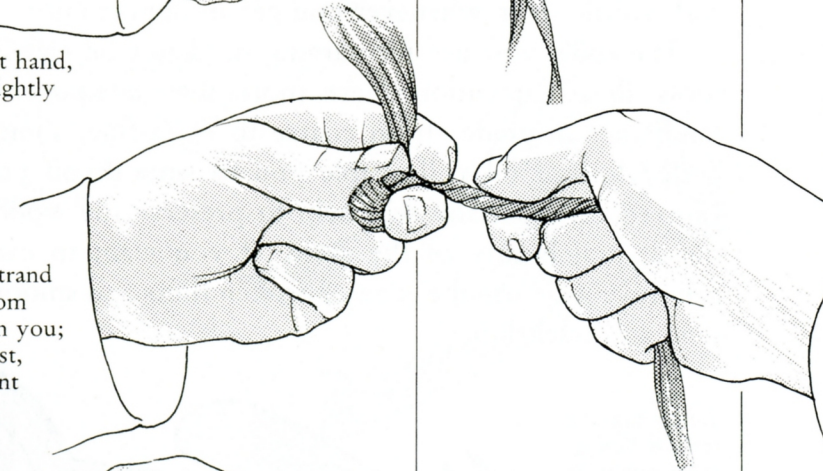
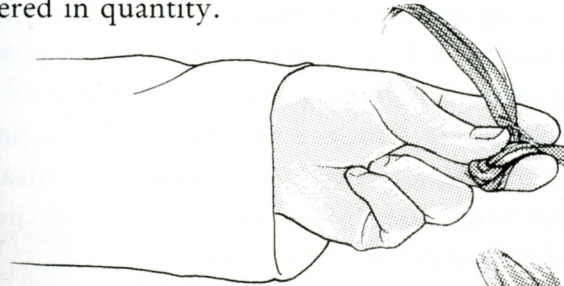

Trapping

Trap designs, born out of detailed observations of animal behaviour, epitomise human ingenuity. I consider traps to be the birthplace of modern mechanics. For traditional northern hunter-gatherers they were – and still are – essential tools of the winter. A trap enabled the hunter to be in many places at once, hunting during the long winter nights; and if the trap was well constructed even dangerous animals such as bears could be taken with minimal risk to the hunter. There was, however, always the risk of injury from a wounded trapped animal.

Traps are illegal today – for very good reasons. The main problem is that, no matter how carefully sited, they are indiscriminate and will take any animal, regardless of whether it is the intended victim. While many primitive traps are cruel, causing distress and suffering to their victim, in emergencies their use is justifiable. Even today, therefore, a knowledge of how to trap can be useful. In the natural world life is harsh, with little room for sentimentality – a fact many people feel uncomfortable with and refuse to accept. The trapper, relying on his wits, has no delusions: his first priority is to catch food to stay alive. However, the skilled trapper should be able to be both successful and humane, by using traps that kill swiftly wherever possible.

Choke toss snare

Goal-post-like framework placed on an animal run

The snare is of strong natural cordage, especially nettle

Trigger-peg wants to swing free but prevented by release stick

Springy sapling set to provide enough force to lift prey's front feet from ground

Snare noose is held open with blades of grass

Release stick set so that prey pushes it down as it tries to move through opening

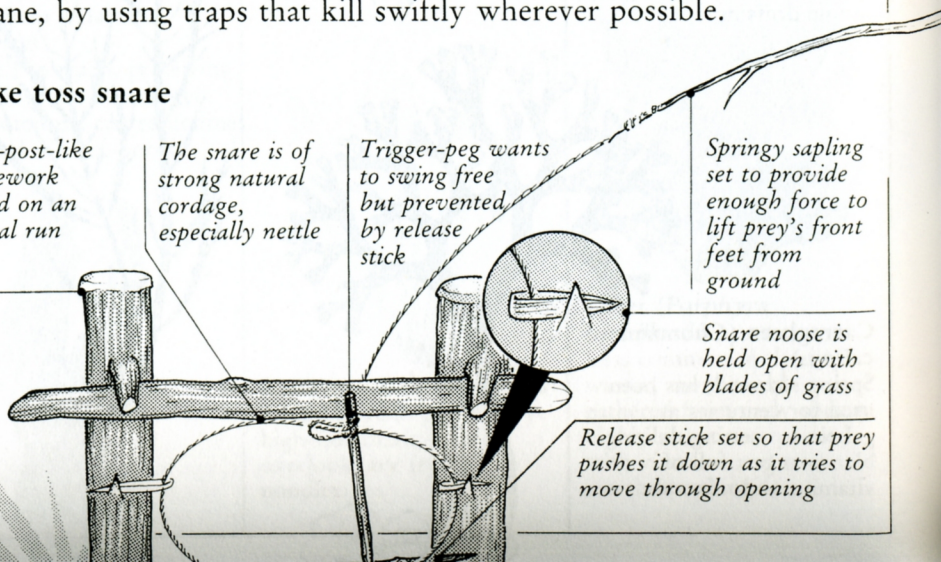

Simple see-saw snare

Supporting tripod should be high enough to allow a good see-saw action; it must be very stable

Notched post acts as trigger, holding tossing bar until dislodged by snared prey

The snare set on the prey's run

Weight should be sufficiently heavy to lift prey into air out of reach of other scavenging carnivores

Less apt to freeze than a bent sapling, a tossing bar is better for really cold weather

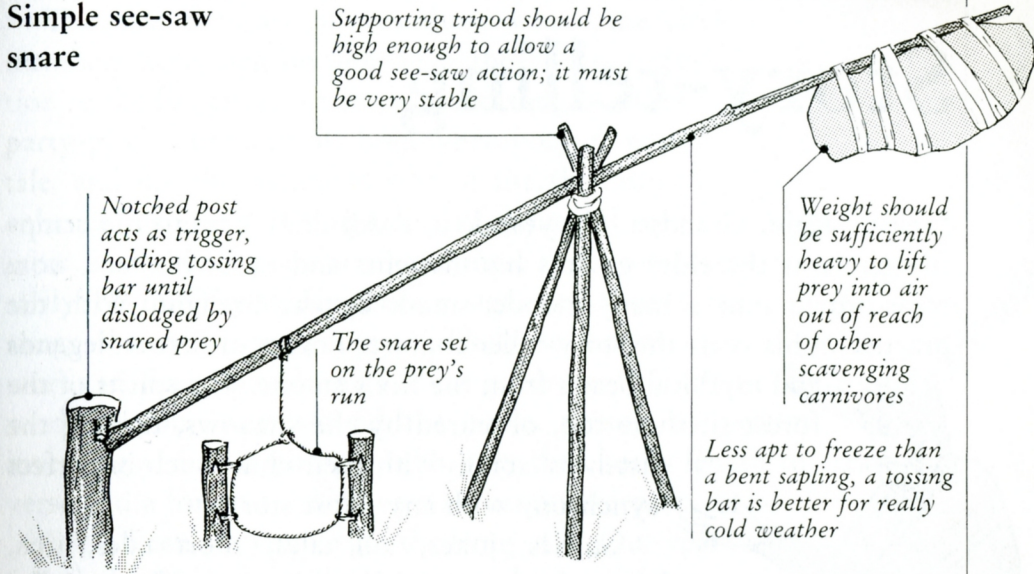

Samson's post dead-fall

Dead-fall crushes prey as it reaches through gap towards bait

A baited trigger-stick balances the supporting Samson's-post

Ojibwa bird-snare

Snare cord of nettle fibres or willow bark is held under tension from bent sapling or dead weight

The noose is draped around the baited perch

When bird lands on it, perch is dislodged, freeing knot which slips through hole under tension of spring arm, making noose tighten around prey's feet

Snare is prevented from passing through hole by knot held fast by end of perch

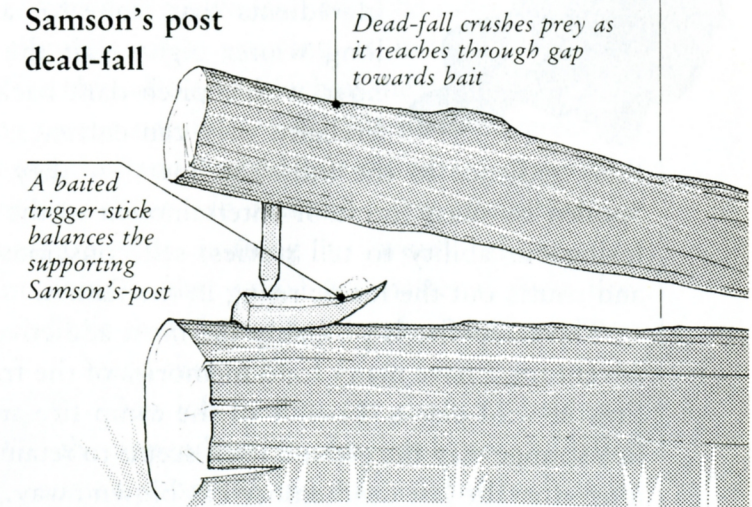

The noose is draped around the baited perch

When bird lands on it, perch is dislodged, freeing knot which slips through hole under tension of spring arm, making noose tighten around prey's feet

Snare is prevented from passing through hole by knot held fast by end of perch

Warning

The traps shown here are illegal and shown only for completeness of content. I do not advocate their use in any situation outside a genuine emergency.

Useful addresses

Courses

Ray Mears

Bushcraft / Survival Courses

Woodlore Ltd
P O Box 3
Etchingham
East Sussex TN19 7ZE
Tel/Fax 0044 (0) 1580 819668
www.raymears.com
Email info@raymears.com

Fungi

British Mycological Society
International Mycological
Institute
Ferry Lane
Kew
Surrey TW9 3AF

Mountain Walking Leader Training Board

Crawford House
Precinct Centre
Booth Street East
Manchester M13 9RZ

The Royal Institute of Navigation

1 Kensington Gore
London SW7 2AT

Tel 0044 (0) 20 7591 3130
Fax 0044 (0) 207591 3131
www.rin.org.uk
Email info@rin.org.uk

The Young Explorers Trust

Royal Geographical Society
1 Kensington Gore
London SW7 2AR
Tel 0044 (0) 207591 3000
Fax 0044 (0) 2075913001
www.rgs.org
Email info@rgs.org

Equipment

Woodlore Ltd

P O Box 3
Etchingham
East Sussex TN19 7ZE
Tel/Fax 0044 (0) 1580 819668
www.raymears.com
Email info@raymears.com

Cutting Tools

Woodlore Knife (designed
by Ray Mears)
Training Knife
Forrest Axe
Wild Life Hatchet Axe
Folding Saw
Bow Saw

Fire Lighting

Fire Stick
Pocket Micro Torch Lighter
Wax Paper

Tee Pee Tents

Light Weight
Heavy Weight

Water Purifier

Pre Mac MWP
Water Bottles
Stainless Steel Mugs

Woolen Clothing

Swanndri Shirts
Swanndri Jackets

Binoculars

Carl Zeiss Ltd

P O Box 78
Woodfield Road
Welwyn Garden City
Herts AL7 1LU
www.zeiss.co.uk
Email binos@zeiss.co.uk

Navigation Equipment

Garmin (Europe) Ltd
Unit 5 The Quadrangle
Abbey Park
Romsey
Hampshire SO1 9AQ
www.garmin.com
Email info@garmin.com

Silva Sweden AB

Box 998
191 29 Sollentuna
Sweden
www.silva.se
Email info@silva.se

Suunto Europe

19 rue des Frefes Lumiere
F-67087 STRASBOURG
Cedex 2
France
www.suuntoeurope.com
Email suunto-europe@media-net.fr

Tents

Hilleberg The Tentmaker

Onevagen 34
SE - 832 51 FROSON
Sweden
www.hilleberg.se
Email tentmaker@hilleberg.se

Water Purification

PRE-MAC

INTERNATIONAL Ltd

Unit 5, Morewood close
Sevenoaks
Kent TN13 2HU
www.pre-mac.com
Email office@pre-mac.com

The Outdoor Survival Handbook is a book of discovery, explaining the everyday skills you need to live in and enjoy the natural world without violating it. Season by season, this unique, fully illustrated guide describes the resources available in the wild and how to use them.

Clear step-by-step instructions and diagrams show how to master all kinds of techniques and projects:

- **Construct a warm, waterproof natural shelter at any time of the year.**
- **Build a good fire in all weathers**
- **Track and identify animals**
- **Orienteer, using map, compass and natural navigation aids**
- **Make tools and equipment from natural materials – pots, baskets, ropes, and much more.**

Packed with practical tips, insights into nature and respect for traditional knowledge, this is a book for families, groups and individual hikers and climbers – for everyone who enjoys the outdoor life.

A master of primitive technology and a specialist in native living skills, Ray Mears regularly teaches and lectures on the outdoors and stars in his own BBC2 series, Ray Mears World of Survival.

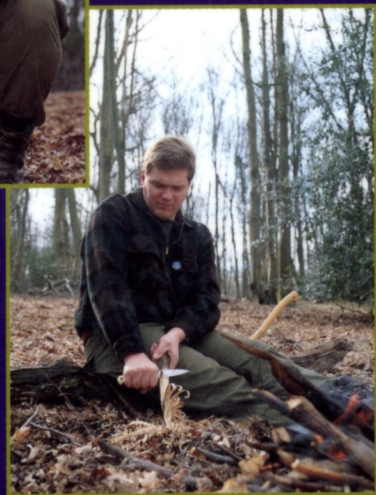
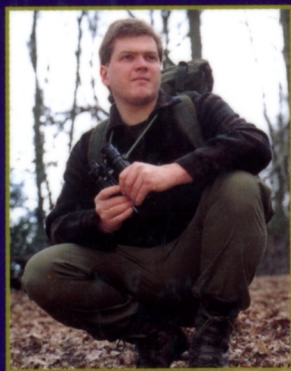

EBURY
PRESS

£12.99

General
Reference

ISBN 0-09-187886-1



9 780091 878863

www.randomhouse.co.uk